

VARIABLE FREQUENCY DRIVE

Operation Manual

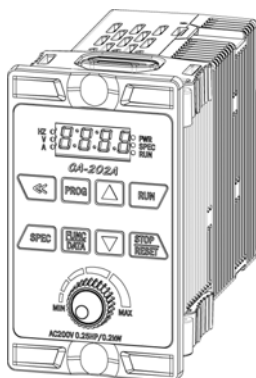

CA Series

PREFACE



Thank you for using TPG CA series drive. For proper operations and safety purposes, please do read and follow specific instructions contained in this manual before using the product.

SAFETY PRECAUTION

Please read this manual thoroughly and pay attention to the safety precautions marked with “**DANGER**” or “**CAUTION**” before the installation, wiring, maintenance, or troubleshooting.

Only the qualified personnel may proceed with the installation, wiring, testing, troubleshooting, or other tasks.

- ※Qualified Personnel: Must be familiar with the fundamentals, structures, characteristics, operating procedures, and installation, and this personnel must read the manual in details and follow the steps of security measures to prevent possible dangers.

 DANGER	User may cause the casualty or serious damages if user does not abide by the instructions of the manual to execute the tasks.
 CAUTION	User may cause injuries to the people or damage the equipment if user does not abide by the instructions of the manual to execute the tasks.

- ※Although the “” mark may indicate minor damages, serious damages or injuries may be possibly incurred if the caution is not under user’s attention.

Installation

 CAUTION
<ol style="list-style-type: none">The installation shall take place only on top of the metal surface or any material with the fire resistant. Any place or location of high temperature, moist, oil and gas, cotton fiber, metal powder and erosive gas shall be avoided.If the product specification indicates IP00 (the protective level of the equipment structure), any human contact is forbidden at the installation location to avoid the electric shock. The option of installing AC reactor(ACL) shall be very cautious.Please note the surrounding temperature shall not exceed 50°C when the installation needs to be placed inside the control panel.For the environment of storage and installation, please follow the instructions of the environmental conditions illustrated in the sections of the common specification of CA.

Wiring



DANGER

- a. Do Not conduct any wiring during the system power ON to avoid the electric shock.
- b. R/L1,S/L2,T/L3 are power inputs (electric source terminals) and U/T1,V/T2,W/T3 are drive's outputs to a motor. Please Do Not connect these input and output terminals to terminals P \oplus , N \ominus , and PR.
- c. Once the wiring is complete, the cover of the drive must be put back and must seal the drive to avoid other's accidental contact.
- d. The drives have three specifications base on the input power source 100V / 200V / 400V, Do Not input the voltage exceed the specifications.
- e. The grounding terminal() must be exactly grounded. Ground the drive in compliance with the NEC standard or local electrical code.
- f. Please refer to the manual page for the screwing torque of the wiring terminal.
- g. Please refer to the national or local electric code for the appropriate spec of the cords and wires.
- h. Please install an appropriate Molded Case Circuit Breaker (MCCB) or Fuse at each path of power lines to a drive.
- i. Please install the thermal relay between the individual motor and the drive when using one drive to propel several motors.
- j. Do Not connect power factor leading capacitor, surge absorber, or non-three-phase motor to the drive's U/T1, V/T2, or W/T3 side.
- k. AC reactor(ACL) installation is required when the power capacity exceeds 500kVA or 10 times or more than the drive rated capacity.
- l. Do Not touch the drive or performing any unwiring actions before drive indicator light turns off after the power off. Use a multi-meter with the DC voltage stage to measure the cross voltage between P \oplus and N \ominus terminals (The voltage must be less than 25V).
- m. When the motor do the voltage-proof, insulation testing, unwiring the U/T1,V/T2,W/T3 terminal of drive at first.





CAUTION

- a. The CA series outputs are designed to drive a three-phase induction motor. Do Not use for single-phase motor or using for other purposes.
- b. The main circuit and control circuit must be wired separately; control circuit must use a shielded or twisted-pair shielded wires to avoid possible interferences.

Operation



DANGER

- a. Do Not open or remove the cover while power is on or during the drive operation. Do close up the cover before powering on the drive. Do Not remove the cover except for wiring or periodic inspection when power off.
- b. At the function F3.30= 1 or 3, the drive will automatically restart when the power is restored. Stay away from the motor and machine.
- c. At the function F1.05=0 and F1.00=0 or 1 or 10, the  key on the operation panel is ineffective. Please use an emergency stop switch separately for safe operations.
- d. The drive can produce high frequency outputs. Before adjusting the frequency, please check the specs of motor carefully to prevent the motor from unexpected damages.
- e. If any of the protective functions have been activated, and the start command is set to terminal control(F1.00=0 or 1 or 10), first remove the case and check the all run commands set to OFF. Then press the  key to release the alarm.



CAUTION

- a. Do Not touch the heat sink or brake resistors due to the high heat.

INTRODUCTIONS

Features

- a. **Special function key(SPEC):**
Programmable function key for forward/reverse running, jog speed, selection of primary/secondary frequency command...etc.
- b. **Allow RS-485 communication interface control (Modbus RTU communication protocol).**
- c. **6 sets of fault records:**
Record 4 types of information under fault condition, respectively. (fault code, output current, DC bus voltage, output frequency)
- d. **Running hours and supply power time of drive can be saved and displayed.**
- e. **Group design for the functions ease the function setting and management.**
- f. **Sequential operation control and PID control function.**
- g. **Provide 8 sets of monitor displays(three of displays can be defined as another extra displays).**
- h. **Provide PTC sensor setting functions for preventing the motor from overheating.**
 - i. **Energy-saving selection for light-duty load.**
 - j. **Auto-torque boost function.**
- k. **Provide 8 preset speeds control.**
 - l. **The analog input signal of filter can be adjusted.**
- m. **The response time of digital input signal is adjustable(adjustable dead band detection).**
- n. **Independent adjustment selection of V, F for analog input signal.**
- o. **Two sets of analog input signals can do addition, subtraction and gain control.**
- p. **The switching frequency can be adjust between 800Hz ~ 16kHz.**

Chapter 1 Cautions Before Installation

1-1 Product Verification

The product has passed the strictest quality test before shipped out from the factory. However, the product might possibly sustain minor damages due to the impact, shaking, vibration, and other factors during the transportation. Please make sure to verify the following items after receiving this product. If the product verification finds anything abnormal, please contact the agent immediately for the further assistance.

1-1-1 Confirmation of Appearance

1. Check up the drive's model number is identical with the shipping label on the carton.
2. Check up the appearance of the drive for any paint chipped off, smearing, deformation of shape, etc.
3. Check up the nameplate (as below figure) of the drive to verify the product descriptions with the order specification.

ISO 9001 IP20

TYPE	CA-202A	→ Model Number
INPUT	1PH AC200-240V 3A 50/60Hz	→ Input Power Specs
OUTPUT	3PH AC200-240V1.5A 0.1-400Hz	→ Output Current & Capacity
PGM NO.	0201-1	→ Software Number
SERIAL NO.	XXXXXXXX	→ Product Serial Number

1-2 Standard Specifications

Model name	CA	CA-201A	CA-202A
Maximum applicable motor (W)		125	200
Rated output capability (VA)		400	600
Rated output current (A)		0.9	1.5
Rated output voltage (V)		Three-phase 200~240V	
Range of output frequency (Hz)		0.1~400Hz	
Power source (ϕ, V, Hz)		1Ø, 200~240V, 50 / 60Hz	
Input current (A)		1.7	3
Permissible AC power source fluctuation		176V~264V 50/60Hz ±5%	
Overload protection		150% of drive rated output current for 1 min.	
Cooling method		Nature cooling	
Protective structure		IP20	
Weight / Mass(kg)		384g	

1-3 Common Specifications

1-3-1 The Features of Control and Operation

Control Characteristics	Control method	<ul style="list-style-type: none"> • Voltage vector sinusoidal PWM control(V/F control); • Switching frequency: 800Hz~16kHz
	Range of frequency setting	0.1~400.00Hz
	Resolution of frequency setting	<ul style="list-style-type: none"> • Operation panel: 0.01Hz • Analog signal: 0.06Hz / 60Hz
	Resolution of output frequency	0.01Hz
	Overload protection	150% of drive rated output current for 1 minute
	DC braking	<ul style="list-style-type: none"> • Start/stop braking time: 0~60.0sec • Stop braking frequency: 0.1~60Hz • Braking ability: 0~150% of rated current
	Braking torque	Approximately 20%(with the external braking resistor connected, braking torque is approximately 100%)
	V/F pattern	<ul style="list-style-type: none"> • V/F pattern (2 V/F points) • Square curve, 1.7th power curve, 1.5th power curve. • Output voltage adjustment of V/F pattern(Variable voltage (V) adjustment of V/F pattern for acceleration / deceleration).
	Acceleration/ deceleration time	<ul style="list-style-type: none"> • 0sec(coast to stop), 0.0~3200.0sec(Independent setting of the acceleration / deceleration). • The time setting range of the speed acceleration from 0 to 60Hz is 0.015sec ~ 1920000sec(222 days).
	Stall prevention	Stall prevention at acceleration / constant speed(the current level of stall prevention is 30~200%), Stall prevention at deceleration
Other functions	Slip compensation, auto-torque compensation, auto-adjustment for output voltage stability, auto-operation for energy-saving, auto-adjustment of switching frequency, restart after instantaneous power failure, speed tracing, over-torque detection, DC braking, dynamic braking duty control, sequential operation control, counter function, PID control, Modbus communication, jump frequency, holding frequency, upper/lower limits of output frequency, 16-preset speeds, acceleration/deceleration switch, S-curve acceleration/deceleration, fan control, parameters duplication, overload detection	

Operation Characteristics	Input	Start method	Command the drive via 3 programmable multi-function input terminals(X1~X3): Forward command / Reverse command, 3-wire start/stop control, 8 sets preset speed control.
		Multi-function inputs	4 programmable input terminals: X1~X3 Response time (1~255, unit: 1ms)
			Refer to the chapter of function setting description for F5.19~F5.21.
	Analog inputs	1 set of analog inputs: AI(DC 0~10V / 2~10V or DC 0~20mA / 4~20mA) Analog filter (0~255, unit: 5ms), the dead band of Analog frequency, gain and bias are adjustable. Refer to the chapter of function setting description for F5.01, F5.02.	
	Output	Multi-function outputs	1-set programmable output terminal: Ta / Tc Refer to chapter of function setting description for F5.26.
		Analog outputs	1 set of analog output: FM(DC 0~10V / 2~10V or DC 0~20mA / 4~20mA) The gain and bias are adjustable. Refer to the chapter of function setting description for F5.12~F5.15.
Environment	Atmosphere	Non-corrosive or non-conductive, or non-explosive gas or liquid, and non-dusty	
	Surrounding temperature	-10°C (14°F) ~ +50°C (122°F) (Non-freezing and non-condensing)	
	Storage temperature	-20°C (-4°F) ~ +60°C (149°F)	
	Relative humidity	90% RH or less (No-condensing atmosphere)	
	Vibration	Less than 5.9m/sec ² (0.6G)	
	Altitude	Less than 1000m (3280 ft.)	

Chapter 2 Installation and Confirmation

2-1 Basic Equipment

The drive needs the several components for the conjunctive operation. These components are called "basic equipment", listed in the following:

2-1-1 Power Source: The voltage with three-phase or single-phase of the power source must meet the drive specifications.

2-1-2 MCCB or NFB: MCCB (Molded Case Circuit Breaker) or NFB (No Fuse Breaker) can withstand the inrush current at instant power-on and providing the overload and over-current protection to the drive.

2-1-3 Drive: The rated current of motors are different for the different pole or rated voltage. Please base on the rated voltage and rated current of motor to select drive. Do not select the drive only base on the horse power specification of motor. (please refer to the lists of standard specifications of drives)

2-1-4 Motor: The specifications of motor are determined from the requirement. Please be cautious to the motor rated current that must not exceed the drive current.

Note: CA is only used for three-phase induction motor control, and must not be used for single-phase motor.

2-2 Environmental Conditions

For the safe operation of the drive, please be cautious to the environmental conditions where the drive is going to be installed.

2-2-1 AC Power: AC power input must be complied with the AC power input specification of the drive.(see CA standard specifications)

2-2-2 Location: Due to the heat dissipating requirement during the drive operation, the drive must keep enough space for heat dissipation. Please keep the least clearance space when installation. (shown as below figure):

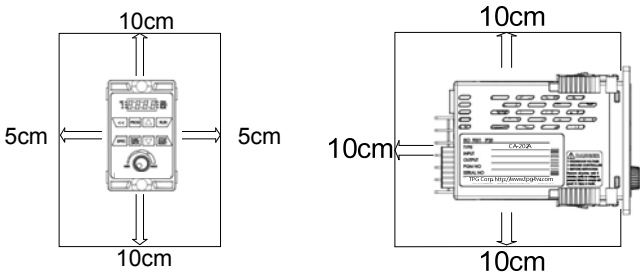

2-2-3 Specifications of Associated Accessories: The specifications of the accessories must be according to the specifications of the drive. Otherwise, the drive will be damaged and the lifetime of the drive will be shorten.



Do Not add any power factor leading capacitor(RC, LC or other capacitance component) between the drive and motor to avoid any accidents.

2-2-4 Cleaning of Environment: The installed location of drive must consider the ventilation, cleanliness and moisture.

2-2-5 Operator: Only the qualified personnel can perform the operation and troubleshooting.

2-3 Descriptions of Terminal and Wiring Diagram

2-3-1 Wiring Diagram

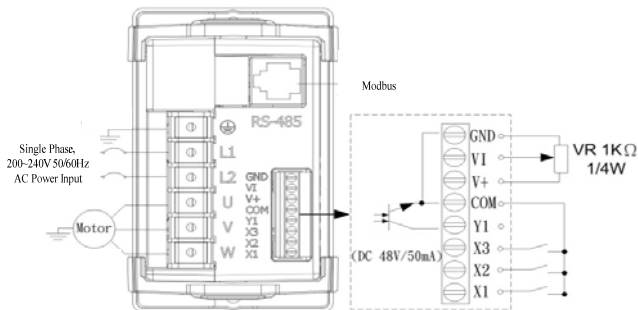

2-3-2 Wiring Diagram

a. Main Circuit Connection

Type	Symbol	Function	Description
Power Source	L1,L2	AC power source input terminals	Single-phase; sinusoidal power source input terminal.(200~240V)
Motor	U,V,W	Drive outputs to motor terminals	The terminals output three phase variable frequency and voltage to motor.
Grounding		Grounding terminal	Ground the drive in compliance with the NEC standard or local electrical code.

b. Control Terminals

Type	Symbol	Function	Description
Input terminals	X1	Multi-function input terminal 1	Short the terminal with COM and set the function F5.19~F5.21.
	X2	Multi-function input terminal 2	
	X3	Multi-function input terminal 3	
Output terminals	Y1	Multi-function output terminal 1	Short the terminal with COM and set the function F5.26
	COM	Input/output common terminal	The common terminal of input control signal.
Control power	V+	Power terminal for analog input control	12V position: Maximum supplied current is 20mA.
	VI	Analog signal input terminal	DC 0~10V

	GND	Common terminal for analog input control	Common terminal for control power (12V/24V) and analog input terminal (AI)
--	-----	--	--

c. Modbus Port (RJ-45)

Type	Pin	Function	Description
Modbus (RS-485) 	1	Communication transmission terminal (DX+)	Differential input of RS-485 *Note 1 Modbus (RS-485) communication only uses pin1, 2.
	2	Communication transmission terminal (DX-)	
	3-8	Reserved	Reserved

Note 1: The terminal resistor(100Ω) selection is set by DSW1(default: ON)

- 8-pin telephone cable: The cable length must be within 5 meters.
- Network cable(AMP): The cable length can be over 5 meters (the longest length is 100 meters)

Chapter 3 The Setting of Operation Panel & Remote Controller

3-1 The Operation of the Operation Panel and Monitor Mode

3-1-1 The Operation of Operation Panel

The operation of the operation panel includes fault messages and three modes. The switching methods are shown as below figure:

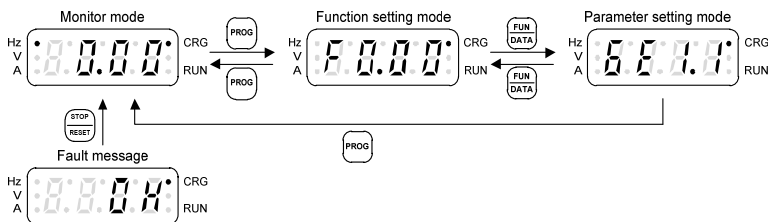

The operation steps are shown in the below table (by default setting)

Operation Steps	Display
1. Start the drive and enter the main display.	Hz V A 0.000 CRG RUN
2. Press PROG key and enter the function setting mode.	Hz V A F0.000 CRG RUN
3. Press FUN/DATA key and enter the parameter setting mode.	Hz V A 6E1.1 CRG RUN
4. Press FUN/DATA key and return to the function setting mode.	Hz V A F0.000 CRG RUN
5. Press PROG key and return to the monitor mode.	Hz V A 0.000 CRG RUN

Fault message display:

Operation Steps	Display
The fault message displayed during the drive operation	Hz V A 0.00H CRG RUN
1. After the error is troubleshot, pressing STOP/RESET key to clear the fault message and then return to the monitor mode.	Hz V A 0.000 CRG RUN

3-1-2 Monitor Mode

There are eight monitor modes can be selected in the monitor mode. User can determine one of eight monitor modes as the main display on the operation panel. And the monitor mode can be switched as shown in below figure:

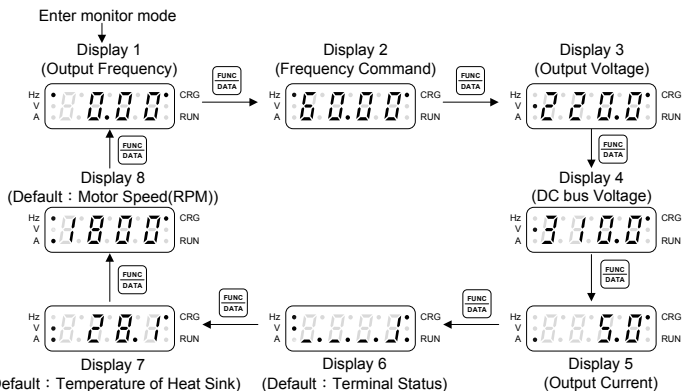

The descriptions of monitor modes are shown in the below table(example by default setting)

Display	Descriptions	Display
Display 1	Output frequency (Hz, CRG: ON)	
Display 2	Frequency command (Hz, CRG: ON)	
Display 3	Output voltage (V, CRG: ON)	
Display 4	DC bus voltage (V, CRG: ON)	
Display 5	Output current (A, CRG: ON)	
Display 6	Terminal status (Hz, V, CRG, RUN: ON)	
Display 7	Heat sink temperature (V, A, CRG: ON)	
Display 8	Motor speed(RPM) (Hz, A, CRG: ON)	

- User can select the main display from eight monitor displays and switch to another monitor displays by key under monitor mode. The selection of monitor displays can be set from F1.08.
- User can determine one of the displays to be the main display according to the demand. If the user does not change the display back the main display after the setting is completed, the drive will automatically switch back to the main display after the operation panel is idle over 3 min.
- The display 6~8 are defined by F1.09~F1.11

3-1-3 The Status of Multi-function Terminals

The default setting of "Display 6" is the status of multi-function input terminals and the definition of each segment on the seven-segment display for 4 digits is shown as below figure:

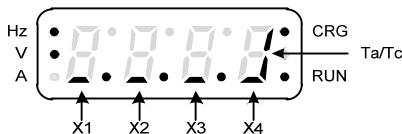

The definition of display shown in the below table:

Display	Terminal	Status description
Hz V A	X1	Multi-function input terminal "X1" is active.
Hz V A	X2	Multi-function input terminal "X2" is active.
Hz V A	X3	Multi-function input terminal "X3" is active.
Hz V A	Y1	Multi-function input terminal "Y1" is active.

3-1-4 The Function Setting Mode







a. The selection of function group:

Operation Steps	Display
1. Press key to enter function group setting mode under monitor mode and the function group in the display will be flashing.	Hz V A
2. Press key to increase the function group number.	Hz V A
3. Press key to decrease the function group number. See "Chapter 4 Parameter List" for the setting range of function groups.	Hz V A

b. The switch of function group and function number:

Operation Steps	Display
1. Press key to switch the function number setting mode to function group setting mode when function group is flashing.	Hz V A
2. Press key to switch the function group setting mode to function number setting mode when function number is flashing.	Hz V A









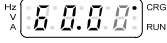

c. The selection of function number:

Operation Steps	Display
1. Press  key to switch to the function number setting mode after the function group is selected. And the function number is flashing.	
2. Press  key to increase the function number.	
3. Press  key to decrease the function number. See "Chapter 4 Parameter List" for the setting range of function numbers.	

Note: The grey-color digits in above tables represent the flashing of the digits.

3-1-5 Parameter Setting Mode

The setting range of parameter is according to the function. The operation steps are shown in the below table:

Operation Steps	Display
1. The function setting mode: example F2.17(output frequency).	
2. Press  key in the function setting mode and enter parameter setting mode.	
3. Press  key to shift the digit; Example: Shift the number to the last digit after the decimal point.	
4. Press  key to increase 0.1 to the output frequency.	
5. Press  key to decrease 0.1 to the output frequency.	
6. Press  key and return to function setting mode.	

a. The digit of parameter value is flashing after the parameter value is changed.

(grey-color digits in above table means digit flashing)

b. The setting range of F2.17 is 0.00~400.00Hz

3-1-6 The Operation in the Monitor Mode

Frequency command, motor speed(RPM), machine speed(MPM) are changeable under monitor mode. For example of frequency command change, the setting steps are shown in the following table.

The operation steps are shown in the below table:

Operation Steps	Display
1.In the monitor mode, the display is shown as right.	Hz V A 60.00 CRG RUN
2.Press ◀◀ key to shift the digit of frequency command.	Hz V A 60.00 CRG RUN
3.Press ◀◀ key to shift the digit of frequency command. Example: Change the digit of decimal value.	Hz V A 60.00 CRG RUN
4.Press ▲ key to increase 1 to the frequency command.	Hz V A 61.00 CRG RUN
5.Press ▼ key to decrease 1 to the frequency command.	Hz V A 60.00 CRG RUN
6.Press FUNC DATA key to save the setting value within 5sec, when completing setting of the rotation speed.	

Note: grey-color digits in above table means digit flashing.

a.Use ▲ or ▼ key to control the rotation speed in the monitor mode.

b.Press FUNC DATA key to save the setting value within 5sec(the setting value is flashing), when the required rotation speed is set. If the setting value is not saved, the display will return to the monitor mode after 5sec and save the value automatically after 3 min. If the saving of the setting value is not completed and drive immediately powers off within 3 min, the setting value will recover to the original value before setting.(see F1.07 for the setting).

3-1-7 Start/Stop of the Drive

Press RUN and STOP RESET key to control the output of drive. Shown as below:

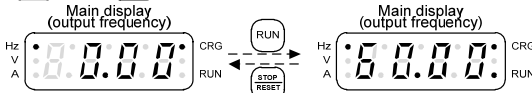



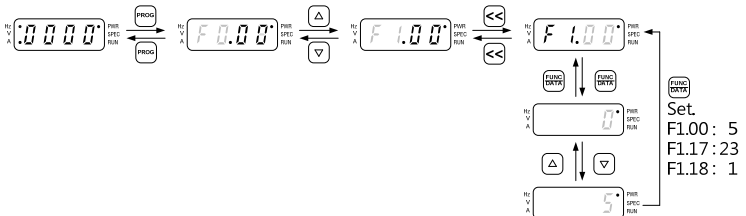







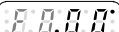

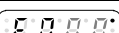
3-1-8 SPEC Programmable Special function key(SPEC) for forward/reverse

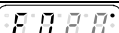



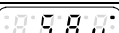

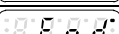
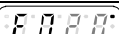

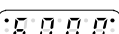



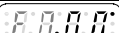

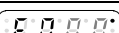
(grey-color digits in above table means digit flashing)

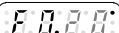
3-1-9 Save and Restore the Setting Value.

a. The operation steps of saving drive function setting are shown in the below table:

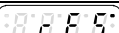
Operation Steps	Display
1. Press  key and enter the function setting mode.	Hz V A  CRG RUN
2. Press  key and switch to the function number setting mode.	Hz V A  CRG RUN
3. Press  key to select F0.20.	Hz V A  CRG RUN
4. Press  key and enter the parameter setting mode.	Hz V A  CRG RUN
5. Press  key and select the "SAV".	Hz V A  CRG RUN
6. Press  key to save settings. The display of operation panel will display "End" after 2sec.	Hz V A  CRG RUN
7. After the panel displays "End" for 1 sec, the display automatically returns to the function setting mode.	Hz V A  CRG RUN
8. Press  key and return to the monitor mode (frequency command).	Hz V A  CRG RUN

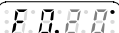
b. The operation steps of resuming drive function setting are shown in the below table:

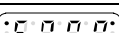
Operation	Display
1. Press  key and enter the function setting mode.	Hz V A  CRG RUN
2. Press  key and switch to the function number setting mode.	Hz V A  CRG RUN
3. Press  key to select F0.20.	Hz V A  CRG RUN
4. Press  key to enter the parameter setting mode.	Hz V A  CRG RUN
5. Press  key and select the "rES".	Hz V A  CRG RUN
6. Press  key to save the setting. The panel will display "End" after 2sec.	Hz V A  CRG RUN
7. After the panel displays "End" for 1 sec, the display automatically returns to the function setting mode.	Hz V A  CRG RUN
8. Press  key and return to the monitor mode (frequency command).	Hz V A  CRG RUN

Chapter 4 Parameter List

Group List(Factory Setting: F0.18=0)

brief version function (F0.18=0)		detail function (F0.18=1)	
Group	Function	Group	Function
F0	System Parameters	F0	System status Parameter locking Password protection Power source voltage setting
F1	Start command selection Frequency command selection Main display selection SPEC key setting Switching frequency Stop mode	F1	Start command selection Frequency command selection Main display selection SPEC key setting Switching frequency Stop mode
F2	Frequency Parameters	F2	Frequency Parameters Preset speed Multi-acceleration/deceleration time V/F pattern setting Upper/lower limits of output frequency
F4	Control Parameters	F3	Control Parameters Holding frequency and time Stall prevention setting Motor slip compensation Automatic boost voltage range Current oscillation prevention Speed tracing Current compensation
F5	Protection Parameters	F4	Protection Parameters Grounding fault protection Drive overload protection Motor overload protection Drive overheat protection Overload protection setting
		F5	Multi-function parameters Analog input Analog output Multi-function input Multi-function output UP/DOWN setting Counting mode Frequency detection
		F6	Special parameters Sequential operation control Modbus communication

F0 System Parameters

Func.	Name	Descriptions	Range of Setting	Unit	Factory Setting	Note
F0.00	Drive Information	0: Software version 1: Drive model number 2: Drive rated current 3: Drive running hours 4: Drive supply power time 5: Software checksum code	—	—	—	
F0.01	Parameter Lock	0: Parameters are changeable 1: Parameters are locked	0, 1	—	0	
F0.02	Reserved	Reserved	—	—	—	*Note 9
F0.03	Reserved	Reserved	—	—	—	*Note 9
F0.04	Reserved	Reserved	—	—	—	*Note 9
F0.05	Power Source	The value of setting according to the actual power source	100.0~120.0 *Note 3 190.0~240.0 *Note 4 340.0~480.0 *Note 5	0.1V	110.0 *Note 3 220.0 *Note 4 380.0 *Note 5	*Note 9
F0.08	Fault Record 1		—	—	—	*Note 9
F0.09	Reserved	0: Fault code	—	—	—	*Note 9
F0.10	Reserved	1: Output current at drive fault	—	—	—	*Note 9
F0.11	Reserved	2: DC bus voltage at drive fault	—	—	—	*Note 9
F0.12	Reserved	3: Output frequency at drive fault	—	—	—	*Note 9
F0.13	Reserved		—	—	—	*Note 9
F0.18	Function	0 : brief 1 : detail function	0 · 1	—	0	
F0.19	Reserved	Reserved				*Note 9
F0.20	Default Setting	0: Disable CLF: Clear fault records dF60: Default the factory setting of 60Hz dF50: Default the factory setting of 50Hz SAv: Store setting rES: Resume setting	—	—	0	

The color as means functions can be set during the operation.

F1 Operation Parameters

Func.	Name	Descriptions	Range of Setting	Unit	Factory Setting	Note	
F1.00	Start Command Selection		Start command	Rotation direction	0~11	—	3
		0	FWD or REV command	FWD or REV command			
		1	FWD command	REV command			
		2	Operation panel	FWD, REV command			
		3		Forward			
		4		Reverse			
		5		Reverse command			
		6~7	Reserved	Reserved			
		8	Communication control	Communication control			
		9	Communication control	Reverse command			
		10	Forward command	Communication control			
		11	Operation panel	Communication control			
F1.01	Primary Frequency Command Selection	0: Frequency command by analog input selection (F1.03). 1: Frequency command by operation panel. 2: Reserved 3: Machine speed setting by operation panel. 4: Frequency command by multi-function input terminal as UP/DOWN command. 5: Frequency command by communication terminal.	0~5	—	1		
F1.02	Secondary Frequency Command Selection	0: Frequency command by analog input selection(F1.03). 1: Frequency command by operation panel. 2: Frequency command by multi-function input terminal as UP/DOWN command.	0~2	—	0	*Note 9	
F1.03	Analog Input Selection	0: Pot knob+ AI 1: Pot knob – AI 2: AI – Pot knob 3: Pot knob or AI(switch by multi-function input terminal) 4: Pot knob 5: AI	0~5	—	0		
F1.04	"Pot knob" Command Source Selection	0: From drive's operation panel. 1: Reserved	0, 1	—	0	*Note 9	

The color as means functions can be set during the operation.

Func.	Name	Descriptions	Range of Setting	Unit	Factory Setting	Note
F1.05	Reserved	Reserved	—	—	—	*Note 9
F1.06	Frequency Command Selection (operation panel)	0: In the monitor mode, frequency command cannot be changed. 1: In the monitor mode, frequency command is changeable.	0, 1	—	1	*Note 9
F1.07	Reserved	Reserved	—	—	—	*Note 9
F1.08	Main Display Selection	Control panel have 8 display option 1: Output frequency 2: Frequency command 3: Output voltage 4: DC bus voltage 5: Output current 6: Terminal status 7: Temperature of heat sink 8: Display mode 8 (F1.11)	1~8	—	1	
F1.09	Reserved	0: Terminal status 1: Temperature of heat sink 2: Motor rotation speed(RPM) 3: Machine speed(MPM) 4: The sector of sequential operation control	—	—	—	*Note 9
F1.10	Reserved	5: The cycle of sequential operation control 6: Counting value 7: Current limit level	—	—	—	*Note 9
F1.11	Display Mode 8	8: Primary frequency command 9: Secondary frequency command 10: PID command 11: PID feedback	0~11	—	2	*Note 9
F1.12	Reserved	Reserved	—	—	—	*Note 9
F1.13	Machine Speed Ratio	Set the ratio of machine speed. This function determines MPM display value.	0.00~500.00	0.01	20.00	
F1.14	Digits of Decimal Value (Machine Speed)	Select the digits of decimal values displaying the machine speed.	0~3	—	0	

The color as means functions can be set during the operation.

Func.	Name	Descriptions	Range of Setting	Unit	Factory Setting	Note
F1.17	SPEC Key Setting	Same function as multi-function input	-28 ~ +28 *Note 7	—	0	
F1.18	SPEC Key Self-Holding Function	0: Disable 1: Enable	0, 1	—	0	
F1.19	Stop Mode	0: Ramp to stop + DC braking 1: Coast to stop 2: Coast to stop+ DC braking	0~2	—	0	
F1.20	Reverse Prohibition	0: Reverse rotation allowed 1: Reversal rotation NOT allowed	0, 1	—	0	*Note 9
F1.21	Switching Frequency	The setting value is higher and the motor noise is lower.	0~6	—	2 *Note 8	
F1.22	Overload Decrease Switching Frequency	0 : The switching frequency will not be adjusted by the load of current. 1 : The swithching frequency will be auto-adjusted according to the load of current.	0,1	—	1	*Note 9
F1.23	Number of Tolerance to Drive Fault	Set the number of tolerance to drive fault conditions when OC, faults are occurred during the certain time period.	0~16	1	0	*Note 9

The color as means functions can be set during the operation.

F2 Frequency Parameters

Func.	Name	Descriptions			Range of Setting	Unit	Factory Setting	Note
F2.00	Primary Speed (Preset Speed 1)	Multi-speed level 3 command	Multi-speed level 2 command	Multi-speed level 1 command	0.00~400.00	0.01 Hz	50.00 *Note 1	
		OFF	OFF	OFF			60.00 *Note 2	
F2.01	Preset Speed 2	OFF	OFF	ON	0.00~400.00	0.01 Hz	10.00	*Note 9
F2.02	Preset Speed 3	OFF	ON	OFF	0.00~400.00	0.01 Hz	20.00	*Note 9
F2.03	Preset Speed 4	OFF	ON	ON	0.00~400.00	0.01 Hz	30.00	*Note 9
F2.04	Preset Speed 5	ON	OFF	OFF	0.00~400.00	0.01 Hz	0.00	*Note 9
F2.05	Preset Speed 6	ON	OFF	ON	0.00~400.00	0.01 Hz	0.00	*Note 9
F2.06	Preset Speed 7	ON	ON	OFF	0.00~400.00	0.01 Hz	0.00	*Note 9
F2.07	Preset Speed 8	ON	ON	ON	0.00~400.00	0.01 Hz	0.00	*Note 9
F2.16	Jog Speed	Jog speed			0.00~400.00	0.01 Hz	6.00	
F2.17	Reference Frequency of Accel/Decel Time	The frequency corresponding to accel/decel time.			0.01~400.00	0.01 Hz	50.00 *Note 1	*Note 9
							60.00 *Note 2	
F2.18	Primary Acceleration Time	The acceleration time of primary speed, preset speed 5~16, and jog speed.			0.0~3200.0	0.1 sec	5.0	

The color as means functions can be set during the operation.

Func.	Name	Descriptions	Range of Setting	Unit	Factory Setting	Note
F2.19	Primary Deceleration Time	The deceleration time of primary speed, preset speed 5~16, and jog speed.	0.0~3200.0	0.1 sec	5.0	
F2.20	Acceleration Time of Preset Speed 2	Acceleration time of preset speed 2	0.0~3200.0	0.1 sec	5.0	*Note 9
F2.21	Deceleration Time of Preset Speed 2	Deceleration time of preset speed 2	0.0~3200.0	0.1 sec	5.0	*Note 9
F2.22	Reserved	Reserved	—	—	—	*Note 9
F2.23	Reserved	Reserved	—	—	—	*Note 9
F2.24	Reserved	Reserved	—	—	—	*Note 9
F2.25	Reserved	Reserved	—	—	—	*Note 9
F2.26	Secondary Acceleration Time	Multi-function input terminals select the secondary acceleration time.	0.0~3200.0	0.1 sec	5.0	*Note 9
F2.27	Secondary Deceleration Time	Multi-function input terminals select the secondary deceleration time.	0.0~3200.0	0.1 sec	5.0	*Note 9
F2.28	Set S-curve for Accel/Decel Time	Set S-curve to slow the acceleration and deceleration at start and stop.	0.0~5.0	0.1 sec	0.0	*Note 9
F2.30	Reserved	Reserved	—	—	—	*Note 9
F2.31	V/F Pattern Selection	0: Linear 1: Energy saving mode (auto-adjust V/F according to the loads) 2: Square curve 3: 1.7 th power curve 4: 1.5 th power curve	0~4	—	0	*Note 9

The color as means functions can be set during the operation.

Func.	Name	Descriptions	Range of Setting	Unit	Factory Setting	Note
F2.32	Maximum Output Frequency	Maximum output frequency of drive	0.1~400.00	0.1Hz	50.0 *Note 1	
					60.0 *Note 2	
F2.33	Starting Frequency	Starting frequency of drive's output frequency.	0.1~10.0	0.1Hz	0.5	*Note 9
F2.34	Starting Voltage	The voltage corresponds to the output starting frequency.	0.1~50.0 *Note 3,4	0.1Vac	8.0 *Note 3,4	
			0.1~100.0 *Note 5		12.0 *Note 5	
F2.35	Base Frequency	The frequency corresponds to the base voltage in V/F pattern.	0.1~400.00	0.1Hz	50.0 *Note 1	
					60.0 *Note 2	
F2.36	Base Voltage	The voltage corresponds to the base frequency in V/F pattern.	0.1~255.0 *Note 3,4	0.1Vac	220.0 *Note 3,4	
			0.1~510.0 *Note 5		380.0 *Note 5	
F2.37	V/F Frequency 1	Frequency at the first point of V/F pattern	0.0~399.9	0.1Hz	0.0	*Note 9
F2.38	V/F Voltage 1	Voltage at the first point of V/F pattern	0.0~255.0 *Note 3,4	0.1Vac	0.0	*Note 9
			0.0~510.0 *Note 5			
F2.39	V/F Frequency 2	Frequency at the second point of V/F pattern.	0.0~399.9	0.1Hz	0.0	*Note 9
F2.40	V/F Voltage 2	Voltage at the second point of V/F pattern.	0.0~255.0 *Note 3,4	0.1Vac	0.0	*Note 9
			0.0~510.0 *Note 5			
F2.42	Jump Frequency 1	Avoid mechanical resonance point 1.	0.0~400.00	0.1Hz	0.0	*Note 9
F2.43	Jump Frequency 2	Avoid mechanical resonance point 2.	0.0~400.00	0.1Hz	0.0	*Note 9
F2.44	Jump Frequency 3	Avoid mechanical resonance point 3.	0.0~400.00	0.1Hz	0.0	*Note 9
F2.45	Jump Frequency Range	Set the range of the jump frequency 1, 2, 3.	0.0~25.5	0.1Hz	0.0	*Note 9
F2.47	Frequency Upper Limit	The upper limit of output frequency (1.00=maximum output frequency)	0.00~1.00	0.01	1.00	
F2.48	Frequency Lower Limit	The lower limit of output frequency (1.00=maximum output frequency)	0.00~1.00	0.01	0.00	

The color as means functions can be set during the operation.

F3 Control Parameters

Func.	Name	Descriptions	Range of Setting	Unit	Factory Setting	Note
F3.00	Holding Frequency	The drive accelerate to the holding frequency and running at constant speed.	0.0~400.00	0.1Hz	0.5	*Note 9
F3.01	Holding Time Interval	The drive runs at holding frequency by constant speed and running the time interval.	0.0~360.0	0.1sec	0.0	*Note 9
F3.03	Stall Prevention Level at the Acceleration	If stall is occurred during acceleration, the motor keeps running at the constant speed(200%: Off).	30%~200% of drive rated current	1%	170	*Note 9
F3.04	Stall Prevention Level at the Constant Speed	If stall is occurred at constant speed running, the motor speed is decreased(200%: Off).	30%~200% of drive rated current	1%	160	*Note 9
F3.05	Acceleration Time for Stall Prevention at the Constant Speed	Set the acceleration time for the stall prevention of the constant speed.	0.1~3200.0	0.1sec	5.0	*Note 9
F3.06	Deceleration Time for Stall Prevention at the Constant Speed	Set the deceleration time at the stall prevention of the constant speed.	0.1~3200.0	0.1sec	5.0	*Note 9
F3.07	Deceleration Stall Prevention	0: Deceleration stall prevention: Disabled 1: Deceleration stall prevention: Enabled	0, 1	—	1	*Note 9
F3.09	Motor Slip Compensation	According to the load condition, set the motor slip compensation for motor running at the constant speed (0.0: Off).	-59.9~60.0	0.1Hz	0.0	*Note 9
F3.10	Frequency Response Time of Motor Slip Compensation	Set the frequency response time of motor slip compensation. Unit: 5ms	1~255	1	40	*Note 9
F3.12	Automatic Boost Voltage Range	According to the load condition, adjust the output voltage of the V/F Pattern (0.0: Off).	0.0~25.5	0.1	1.0	*Note 9

The color as means functions can be set during the operation.

Func.	Name	Descriptions	Range of Setting	Unit	Factory Setting	Note
F3.13	Response Time of Automatic Boost Voltage	Set the response time of automatic boost voltage range.	1~255	1ms	60	*Note 9
F3.18	Automatic Voltage Regulation (AVR)	0: Disable 1: Enable	0, 1	—	1	*Note 9
F3.19	Response Time of AVR	Set the response time of automatic voltage regulation.	0~255	1ms	50	*Note 9
F3.21	DC Braking Level	Set the current level of DC braking	0~150% of drive rated current	1%	50	*Note 9
F3.22	DC Braking Response Time	Adjust the response time according to DC braking.	1~255	1ms	10	*Note 9
F3.23	Time Interval of DC Braking at Start	Set the time interval for DC braking before drive starts.	0.0~60.0	0.1sec	0.0	*Note 9
F3.24	Time Interval of DC Braking at Stop	Set the time interval for DC braking at drive stops.	0.0~60.0	0.1sec	0.5	*Note 9
F3.25	DC Braking Frequency at Stop	Active frequency level of DC braking at stop.	0.1~60.0	0.1Hz	0.5	*Note 9
F3.27	Active Level of Dynamic Brake	Dynamic brake activates when the DC bus voltage is over the setting. Function disable setting: 100/200V series: 410 400V series: 820	350~410 *Note 3,4	1Vdc	390 *Note 3,4	*Note 9
			700~820 *Note 5		780 *Note 5	

The color as means functions can be set during the operation.

Func.	Name	Descriptions	Range of Setting	Unit	Factory Setting	Note
F3.28	Pulse Setting of Braking Transistor	Set the pulse width of drive braking signal.	10~90	1%	50	*Note 9
F3.30	Operation Selection at Instantaneous Power Failure	0: Drive cannot be restarted 1: Drive can be restarted 2: Ramp to stop (please refer to the F3.31~F3.35) 3: When the power is restored during the ramp to stop interval, the drive re-accelerates again	0~3	—	0	*Note 9
F3.31	The Voltage Level Setting at Power Failure	Set the voltage level of power source for ramp to stop. When the voltage of power input is lower than the setting level, drive ramps to stop.	75.0~96.0 *Note 3	0.1V	87.5 *Note 3	*Note 9 *Note 9
			150.0~192.0 *Note 4		175.0 *Note 4	
			300.0~384.0 *Note 5		320.0 *Note 5	
F3.32	Subtracted Frequency of Deceleration at Power Failure	When the power failure, the output frequency = drive's original output frequency - subtracted frequency.	0.0~20.0	0.1Hz	3.0	*Note 9
F3.33	Deceleration Time 1 at Power Failure	Set a deceleration time down to the turning frequency set in (F3.35).	0.0~3200.0	0.1sec	5.0	*Note 9
F3.34	Deceleration Time 2 at Power Failure	Set a deceleration time below the turning frequency set in (F3.35).	0.0~3200.0	0.1sec	5.0	*Note 9
F3.35	Turning Frequency at Power Failure	Set the turning frequency level at power failure that the deceleration time is switched from the F3.33 setting to the F3.34 setting.	0.0~400.00	0.1Hz	0.0	*Note 9
F3.37	The Current Level of Speed Tracing	When the current large than the tracing current, the output frequency is tracing downward.	0~200% of drive rated current	1%	150	*Note 9
F3.38	Delay Time for Speed Tracing	Set the output delay time before the speed tracing.	0.1~60.0	0.1sec	0.5	*Note 9
F3.39	The V/F Pattern of Speed Tracing	Set the percentage of V/F output voltage at the speed tracing.	0~100%	1%	100	*Note 9

The color as means functions can be set during the operation.

F4 Protection Parameters

Func.	Name	Descriptions	Range of Setting	Unit	Factory Setting	Note
F4.07	Motor Overload Protection (OL)	0: Motor overload protection: Disabled 1: Motor overload protection: Enabled(OL) 2: Motor overload protection of independent cooling fans: Enabled(OL)	0~2	—	1	*Note 9
F4.08	Motor Rated Current	Current setting according to the motor rated current.	10%~150% of drive rated current	0.1A	According to the rated current of motor	
F4.09	Motor No-Load Current	Current setting according to the motor's no-load condition	0~ motor rated current	0.1A	1/3 motor rated current	*Note 9
F4.10	Trip Time of Motor Overload	Set the tripped time of motor when motor is overload(150% of Motor rated current).	0.5~10.0	0.1min	5.0	*Note 9
F4.12	Protection Level of Drive Overheat	Set the tripped level of drive when drive is overheat.	85~115	1℃	90 *Note 6	*Note 9
F4.13	Drive Overheat Pre-alarm Selection	0: Disable 1: Warning (OHT): Continuous operation (relay terminal outputs) 2: Warning (OHT): Reduce switching frequency operation (relay terminal outputs) 3: Warning (OHT): Stop operation (relay terminal outputs)	0~3	—	2	*Note 9

The color as means functions can be set during the operation.

Func.	Name	Descriptions	Range of Setting	Unit	Factory Setting	Note
F4.14	Drive Overheat Pre-alarm Level	Set the temperature level of warning alarm.	45~105	1℃	70	*Note 9
F4.15	Drive Overheat Dead Band	Set the temperature dead band of temperature warning and fan active level.	0.1~10.0	0.1℃	3.0	*Note 9
F4.17	Fan Control Selection	0: Forced air: Start the fan at power on. 1: Operation air: Start the fan at operation. 2: Temperature control: Fan activation according to temperature level	0~2	—	1	*Note 9
F4.18	Temperature Level of Fan Activation	Set the temperature level of fan activation.	25~60	1℃	50	*Note 9
F4.19	Minimum Operation Time of Fan	Set the minimum operation time of fans when the fan control is stopped.	0.1~25.0	0.1min	0.5	*Note 9
F4.21	PTC Overheat Warning Level (Motor Overheat Protection)	Set the temperature warning level(OH1) of PTC	0.0~10.0	0.1Vdc	1.2	*Note 9
F4.22	PTC Overheat Warning Disposal	0: Warning (OH1): Continue operation (relay terminal outputs) 1: Warning (OH1): Stop operation (relay terminal outputs)	0, 1	—	0	*Note 9
F4.23	PTC Overheat Trip Level	Set the overheat trip level of PTC	0.0~10.0	0.1V	2.4	*Note 9
F4.25	System Overload Detection (OLO)	0: Disable 1: Enable(OLO)	0, 1	—	0	*Note 9
F4.26	System Overload Detection Status	0: Detection during the constant speed only 1: Detection during the running only	0, 1	—	0	*Note 9
F4.27	Output Setting of System Overload	0: Drive is still running when the overload is detected 1: Drive is tripped when the overload is detected	0, 1	—	0	*Note 9
F4.28	System Overload Detection Level	Set the level of the current for overload detection	30%~200% of drive rated current	1%	160	*Note 9
F4.29	System Overload Detection Time	The output current is larger than the setting F4.28 and exceeds the time interval of the overload detection	0.1~300.0	0.1sec	0.1	*Note 9

The color as means functions can be set during the operation.

Func.	Name	Descriptions	Range of Setting	Unit	Factory Setting	Note
F4.36	Current Limit (I-limit)	Current over F4.36 × the rated current of drive during operation, the drive may adjust PWM output and limit output current.	30%~200% of drive rated current	1%	180	*Note 9
F4.37	Gain of I-limit	The gain of the current limitation response(P).	0.00~1.00	0.01	0.10	*Note 9
F4.38	Integration Time of I-limit	Lower integration time I setting value will result the current limitation response more fast but lower setting value would cause the effect of oscillating current.	0~10.0	0.1	0.6	*Note 9
F4.39	Selection of Current Limitation	0:Disable 1:Enable	0,1	—	0	*Note 9

The color as means functions can be set during the operation.

F5 Multi-function Parameters

Func.	Name	Descriptions	Range of Setting	Unit	Factory Setting	Note
F5.00	"Pot knob" Selection (Analog Input)	0: Analog input gain 1: Frequency command 2: Current limit 3: Variable voltage of V/F pattern	0~3	—	1	*Note 9
F5.01	AI Selection (Analog Input)	0: Analog input gain 1: Frequency command 2: Current limit 3: Variable voltage of V/F pattern 4: PTC temperature 5: PID feedback	0~5	—	1	*Note 9
F5.02	Reserved	Reserved				*Note 9
F5.03	Pot Gain (Analog Input)	Analog input of "Pot knob" gain	0.00~2.00	0.01	1.00	*Note 9
F5.04	"Pot knob" Bias (Analog Input)	Analog input of "Pot knob" bias	-1.00~1.00	0.01	0.00	*Note 9
F5.05	AI Gain (Analog Input)	Analog input of AI gain	0.00~2.00	0.01	1.00	*Note 9
F5.06	AI Bias (Analog Input)	Analog input of AI bias	-1.00~1.00	0.01	0.00	*Note 9
F5.07	Filter Setting of Analog Frequency	Filter the signal based on analog input setting.	0~255	—	20	*Note 9
F5.08	Analog Frequency Dead Band	When signal noise is large, appropriately increase the dead band to stabilize the frequency. But this will reduce the tuning linearity.	0.00~2.55	0.01Hz	0.00	*Note 9
F5.09	Acceleration Time of V	Set the acceleration time of the variable voltage of V/F pattern.	0.0~3200.0	0.1sec	5.0	*Note 9
F5.10	Deceleration Time of V	Set the deceleration time of the variable voltage of V/F pattern.	0.0~3200.0	0.1sec	5.0	*Note 9

The color as means functions can be set during the operation.

Func.	Name	Descriptions	Range of Setting	Unit	Factory Setting	Note
F5.19	Multi-function Input Terminal X1	0: Disable ±1: Jog command ±2: Secondary accel/decel command switching ±3: Multi-speed level 1 command ±4: Multi-speed level 2 command ±5: Multi-speed level 3 command ±6: reserved ±7: Reset command ±8: External fault command(EF) ±9: Interruption of output command(bb) ±10: Coast to stop command(Fr)	-28 ~ +28 *Note 7	—	22	
F5.20	Multi-function Input Terminal X2	±11: Speed search from the maximum frequency ±12: Speed search from the frequency ±13: Holding command ±14: UP command ±15: DOWN command ±16: Clean UP/DOWN frequency command ±17: UP/DOWN command enter key ±18: Analog input source selection (Pot knob/AI) ±19: Primary and secondary frequency command option	-28 ~ +28 *Note 7	—	23	
F5.21	Multi-function Input Terminal X3	±20: Start command of sequential operation control ±21: Pause command of sequential operation control ±22: Forward command ±23: Reverse command ±24: Stop command with 3-wire start/stop circuit ±25: DC braking enable (Stop) ±26: Counter input ±27: Counter clear ±28: Current limit enable	-28 ~ +28 *Note 7	—	1	
F5.25	Digital Input Response Time	When the input signal is under the setting time, program will not be activated.	1~255	1ms	10	*Note 9

The color as means functions can be set during the operation.

Func.	Name	Descriptions	Range of Setting	Unit	Factory Setting	Note
F5.26	Multi-function Output Setting of Ta/Tc Terminals	0: Disable ±1: Running detection ±2: Constant speed detection ±3: Zero speed detection ±4: Frequency detection ±5: Overload detection(OLO) ±6: Stall prevention detection ±7: Low voltage detection(LE) ±8: Braking transistor is active detection(db) ±9: Restart after instantaneous power failure detection ±10: Restart after fault condition detection ±11: Fault detection ±12: Start detection of sequential operation control ±13: One complete operation sector detection of sequential operation control ±14: One complete operation cycle detection of sequential operation control ±15: Pause command detection of sequential operation control ±16: Detection of counter value1 ±17: Detection of counter value2 ±18: Reverse detection ±19: NTC temperature warning detection (OHT) ±20: Fan operation detection ±21: PTC temperature warning detection (OH1)	-21~+21 *Note 7	—	11	
F5.30	UP/DOWN Memory Selection	0: Erase UP/DOWN frequency command when power off 1: Store UP/DOWN frequency command when power off	0, 1	—	0	*Note 9
F5.31	UP/DOWN Frequency Calibration	0: 0.01Hz 1~8: ×0.05Hz 9: 0.5Hz 10~250: ×0.1Hz	0~250	—	0	*Note 9

The color as means functions can be set during the operation.

Func.	Name	Descriptions	Range of Setting	Unit	Factory Setting	Note
F5.32	UP/DOWN Calibrating Time	1~5: Terminal adjust the response time. Continuous acceleration or deceleration when over the setting time 6: Edge trigger	1~6	—	1	*Note 9
F5.33	UP/DOWN Frequency Adjustment	Adjust UP/DOWN frequency on keypad directly	0.00~400.00	0.01Hz	0.00	*Note 9
F5.35	Counting Mode	0: Up counting mode 1: Down counting mode	0, 1	—	0	*Note 9
F5.36	Counter Value 1	Set counter value 1 for sequential operation control cycle	0~9999	1	0	*Note 9
F5.37	Counter Value 2	Set counter value 2 for sequential operation control cycle	0~9999	1	0	*Note 9
F5.39	Constant Speed Detection Range	Set the bandwidth of constant speed detection range	0.0~10.0	0.1Hz	2.0	*Note 9
F5.40	Frequency Detection Range	Set the bandwidth of frequency detection range	0.0~10.0	0.1Hz	2.0	*Note 9
F5.41	Frequency Detection Level	Set the frequency detection level of multi-function terminal	0.0~400.00	0.1Hz	0.0	*Note 9

The color as means functions can be set during the operation.

F6 Special Parameters

Func.	Name	Descriptions	Range of Setting	Unit	Factory Setting	Note
F6.55	Communication Address	The host uses the address to send and receive messages from the drive (0: Disable)	0~254	—	0	*Note 9
F6.56	Baud Rate	0: 4800bps 1: 9600bps 2: 19200bps	0~2	—	1	*Note 9
F6.57	Communication Protocol	0: 8,N,2 1: 8,E,1 2: 8,O,1	0~2	—	1	*Note 9
F6.58	Communication Overtime (Cot)	When the data transmission during communication transmission is interrupted, has no data transmitting, or delays, drive displays "Cot" message (0.0: Communication overtime disable)	0.0~100.0	0.1sec	0.0	*Note 9
F6.59	Communication Overtime Disposal	0: Warning (Cot): Continue operation. 1: Warning (Cot): Ramp to stop 2: Warning (Cot): Coast to stop	0~2	—	0	*Note 9
F6.60	Multi-Function Input Selection	0: Multi-function inputs from multi-function terminals 1: Multi-function inputs from communication control	0, 1	—	0	*Note 9

(Note):

- The default setting of 50Hz
- The default setting of 60Hz (Factory Setting)
- Specifications of 100V series
- Specifications of 200V series
- Specifications of 400V series
- The default value is "105" for 2003B1/2003B3~2005B3/4005B3~4007B3 models and the default value is "90" for remained models.
- + : Represents a contact (Normal open), — : Represents b contact (Normal close)
UP/DOWN control wiring must not exceed over 20m when multi-function terminals are used for UP/DOWN control.
- When the setting value of switching frequency(F1.21) exceeds "4", the drive must be de-rating for usage or selecting the higher capacity of drive.
- Setting F0.18=1.

The color as means functions can be set during the operation.

Chapter 5 Parameter Setting Description

F0 System Parameters

【F0.00】 Drive Information

- The function can display the horse power and software version. Check if the capacity of drive corresponding to the drive by this function.
- This manual and software version must be identical.
The drive with different software version cannot duplicate drive parameters, or the drive operation panel will display Wr_F.
- The descriptions of LED indicators shows the different displays of the operation panel, and LED indicator displays are shown as below table.
- The left 2th bits of drive model number for 200V single-phase series displays "S".

Hz	V	A	
<input type="radio"/>	<input type="radio"/>	<input type="radio"/>	Software version
<input checked="" type="radio"/>	<input type="radio"/>	<input type="radio"/>	Drive model number
<input type="radio"/>	<input checked="" type="radio"/>	<input type="radio"/>	Drive rated current
<input checked="" type="radio"/>	<input checked="" type="radio"/>	<input type="radio"/>	Drive running hours
<input type="radio"/>	<input type="radio"/>	<input checked="" type="radio"/>	Drive supply power time(Hours)
<input checked="" type="radio"/>	<input type="radio"/>	<input checked="" type="radio"/>	Software checksum code

【F0.01】 Parameter Lock

- Protect the parameter settings to prevent parameter settings from unexpected adjustments causing the system operated incorrectly.
- The parameter setting as the following
0: Parameters are changeable
1: Parameters are not changeable

【F0.05】 Power Source

- The power source setting as the following table

Power source specification	Range
100V series	100.0~120.0V
200V series	190.0~240.0V
400V series	340.0~480.0V

- The power source setting must be according to the actual power source and the setting will affect the activation validity of LE, LE1 and the validity of V/F outputs.

【F0.08】 Fault Record 1

- Record the latest 6 times of fault messages.
- The fault messages selection are listed as the following:
0: Fault code
1: Output current at drive fault
2: DC bus voltage at drive fault
3: Output frequency at drive fault

【F0.18】 Function

0 : brief

1 : detail function

【F0.20】 Default Setting

a. Default settings are shown as the below table:

8880	Disable
0000	Clear fault records
6660	Default the factory setting of 60Hz (All SAV setting will be clear)
5550	Default the factory setting of 50Hz (All SAV setting will be clear)
5880	Store setting
8885	Resume setting
8888	Read the parameters from drive to digital keypad
4888	Write the parameters from digital keypad to drive

b. After setting all parameters, select SAV to save all settings in case for restoring parameters.

F1 Operation Parameters

【F1.00】 Start Command Selection

a. F1.00 = 0

- (I) Motor forward and reverse directions are controlled by multi-function input terminals(X1~X4).
- (II) Start and motor rotating direction commands are controlled by multi-function input terminals(X1~X4) for forward and reverse command.
- (III) The motor stops running when the multi-function input terminals are set (closed) or open simultaneously.

Example: Parameter value: F5.19=22 (define X1 as forward command),
F5.20=23 (define X2 as reverse command) and the drive control is shown as the below diagram.

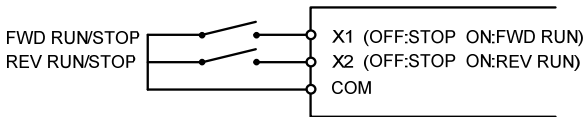

b. F1.00 = 1

- (I) Motor forward and reverse directions are controlled by multi-function input terminals (X1~X4).
- (II) Start command by forward command (defining X1~X4 as forward command) and motor rotating direction by reverse command (defining X1~X4 as reverse command).

Example: Parameter value: F5.19=22(define X1 as forward command),
F5.20=23(define X2 as reverse command) and the drive control is shown as the below diagram.

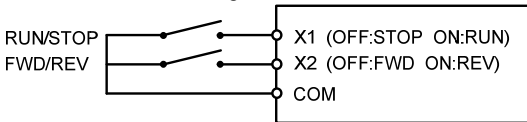

c. F1.00 = 2

- (I) Motor rotating direction are controlled by multi-function input terminals (X1~X4).
- (II) Start command by "RUN" key of the operation panel and the rotation direction by forward or reverse command defined by multi-function input terminals (X1~X4).
- (III) The motor stops running when the multi-function input terminals (forward/reverse commands) are set closed or open simultaneously.

Example: Parameter value: F5.19=22(define X1 as forward command), F5.20=23(define X2 as reverse command) and the drive control is shown as the below diagram.

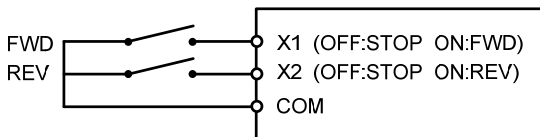

d. F1.00 = 3

- (I) Start command by "RUN" key of the operation panel and the motor rotates at the forward direction (clockwise).
- (II) Forward and reverse commands are disabled.

e. F1.00 = 4

- (I) Start command by "RUN" key of the operation panel and the motor rotates at the reverse direction (counterclockwise)
- (II) Forward and reverse commands are disabled.

f. F1.00 = 5

- (I) Multi-function input terminals (X1~X4) define as the reverse command and the motor runs at the reverse direction (counterclockwise).
- (II) Start command by "RUN" key of the operation panel and the rotation direction is controlled by reverse command (defining multi-function input terminals as reverse command).

Example: Parameter value: F5.19=23 (define X1 as the reverse command) and drive control is shown as the below diagram

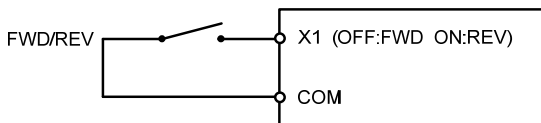

g. F1.00 = 6~7
Reserved

h. F1.00 = 8

- (I) Start command and the motor rotating direction are controlled by communication.
- (II) Forward and reverse commands are disabled.

i. F1.00 = 9

- (I) Multi-function input terminals(X1~X4) define as the reverse command and the motor runs at the reverse direction (counterclockwise).
- (II) Start command is given by communication control, and the motor rotating direction is defined by reverse command (defined by multi-function input terminals).

j. F1.00 = 10

- (I) Multi-function input terminals(X1~X4) define as the reverse command and the motor runs at the reverse direction (counterclockwise).
- (II) Start command is given by forward command (defined by multi-function input terminals) and the motor rotating direction is controlled by communication.
- (III) Forward and reverse commands are disabled.

k. F1.00 = 11

- (I) Start command by "RUN" key of the operation panel and the motor rotating direction by communication.
- (II) Forward and reverse commands are disabled.

※F1.00 = 0 or 2

If the forward and reverse commands are active at the same time, the operation panel will display "-----" along with inter-flashing display value at monitor mode. If the forward and reverse commands are set (closed) simultaneously, the operation panel will be flashing to display "dtF" in the monitor mode.

※When the motor rotation direction is set to reverse, the output frequency will display "-" and the reversed indicator will ON.

【F1.01】 Primary Frequency Command Selection

a. F1.01 = 0

The frequency is controlled by analog input terminal (select the analog input source: "Pot knob", AI by defining function F1.03)

(I) "Pot knob":

For the gain and bias ranges of frequency settings, please refer to functions F5.03 and F5.04.

(II) AI-GND:

For the gain and bias ranges of frequency settings, please refer to functions F5.05 and F5.06.

Select the input mode by JP1



JP1→I mode:

The range of input current is 4~20mA or 0~20mA (selection by function F5.02)

JP1→V mode:

The range of input voltage is 2~10V or 0~10V (selection by function F5.02)

b. F1.01 = 1

The frequency command can be set by function F2.00 using operation panel and by   key in the monitor mode as well.

c. F1.01 = 3

MPM command is set using the operation panel.

d. F1.01 = 4





UP/DOWN command control.

Selection by multi-function input terminal X1~X4(UP command, DOWN command, Clear the frequency command by UP/DOWN, Confirm the frequency command by UP/DOWN).

e. F1.01 = 5

Frequency command is set by communication control.

※ F1.01 = 1~3

Press  or  key one time in the monitor mode. The value of the frequency command in the panel display will be blinking but not changed. Press  or  key again to change frequency command.

【F1.02】 Secondary Frequency Command Selection

Set functions F5.19~F5.22 as ± 19 , and switch the primary/secondary frequency command by multi-function input terminals.

The settings are listed as the following: (see the parameter description of F1.01)

0: Analog input setting

1: Operation panel setting

2: UP/DOWN setting

【F1.03】 Analog Input Selection

The settings are listed as below: (see the parameter description of F5.00~F5.01)

0: "Pot knob" + AI

1: "Pot knob" - AI

2: AI - "Pot knob"

3: "Pot knob" or AI (switched by multi-function input terminals)

4: "Pot knob"

5: AI

※ "Pot knob" is on the operation panel, and AI is the analog input terminal.

【F1.04】 "Pot knob" Command Source Selection

The settings are listed as below:

0: From drive's operation panel.

1: From external keypad (KP-601).

【F1.06】 Frequency Command Selection (operation panel)

The settings are listed as below:

- 0: The frequency command cannot be changed in the monitor mode to avoid the fault occurred by changing the frequency in the monitor mode.
- 1: The frequency command can be changed in the monitor mode.

【F1.07】 Frequency Command Auto-Storing (operation panel)

The settings are listed as below:

- 0: The frequency command setting does not auto-store in the monitor mode.
- 1: The frequency command setting is auto-stored after 3 minutes in the monitor mode.

【F1.08】 Main Display Selection

a. The settings are listed as below:

- 1: Output frequency
- 2: Frequency command
- 3: Output voltage
- 4: DC bus voltage
- 5: Output current
- 6: Terminal status
- 7: Temperature of heat sink
- 8: Display mode 8 (F1.11)

b. Above display modes can be selected as the primary display and other display modes becomes secondary display modes.

c. When the drive is idle without any operation for 3 minutes, the secondary display will be automatically changed to the primary display mode.

【F1.11】 Display Mode 8

The settings are listed as below:

- 0: Terminal status
- 1: Temperature of heat sink
- 2: Motor rotation speed(RPM)
- 3: Machine speed(MPM)
- 4: The sector of sequential operation control
- 5: The cycle of sequential operation control
- 6: Counting value
- 7: Current limit level
- 8: Primary frequency command
- 9: Secondary frequency command
- 10: PID command
- 11: PID feedback

【F1.13】 Machine Speed Ratio

The machine speed display in the monitor mode

$$\text{Machine speed} = \text{Machine speed ratio (F1.13)} \times \text{Output frequency}$$

【F1.14】 Digits of Decimal Value (Machine Speed)

Set the digits of decimal values (the range from 0~3 digits behind the decimal point) to display the higher resolution of machine speed for observation of machine speed.

【F1.17】 SPEC Key Setting

The setting of SPEC key is similar as multi-function input setting; see the function F5.19 ~ F5.22 for SPEC key setting reference.

【F1.18】 SPEC Key Self-Holding Function

SPEC key self-holding function

- 0: Disable
- 1: Enable

Example: SPEC key is set as reverse command.

- Start command(F1.00) is set as 5 (Start the drive by operation panel)
- Set function F1.17 as 23 (reverse command)
- Set function F1.18 as 1 for holding operation and press "SPEC" key during the drive operation, and motor will run in reverse direction.

【F1.19】 Stop Mode

a. The settings are listed as below:

- 0: Ramp to stop + DC braking (see functions F3.21 ~ F3.35)
- 1: Coast to stop (inertia stop)
- 2: Coast to stop + DC braking

b. When F1.19=2, the stop operation is shown in the below diagram:

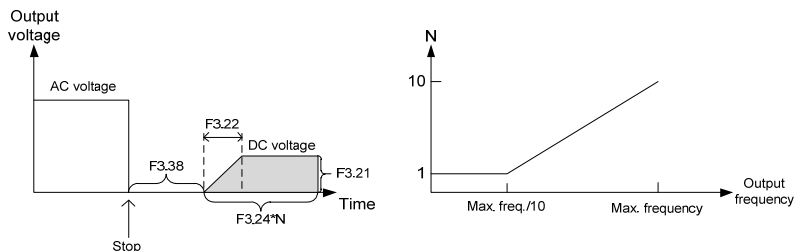

c. When the output current is abnormal at DC braking, adjust the suitable time by function F3.38 to release the remained magnet of rotor and then to perform DC braking.

【F1.20】 Reverse Prohibition

The settings are listed as below:

- 0: Reverse rotation allowed
- 1: Reversal rotation NOT allowed

【F1.21】 Switching Frequency

a. The settings are listed in the below table:

Setting Value	Switching frequency
0	800Hz
1	2.5kHz
2	5kHz
3	7.5kHz
4	10kHz
5	12.5kHz
6	16kHz

- b. De-rate the output current of drive if the switching frequency setting value is over 4.
- c. The higher switching frequency has less noise. But using higher switching frequency must consider the cable length between drive and motor and must be adjusted according the connection distance between drive and motor (see wiring installation in section 2-3-4)
- d. Switching frequency limit: The limit of switching frequency will be auto-adjusted according to the load condition (see the below diagram for load condition vs. switching frequency auto-de-rating).
- e. The setting value of switching frequency is higher and the motor noise is lower.

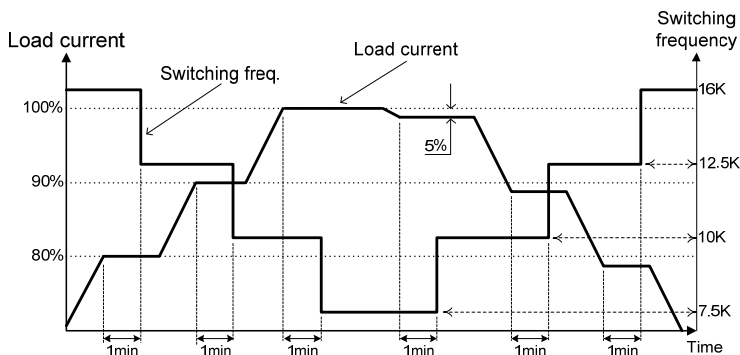

【F1.22】 Overload Decrease Switching Frequency

The settings are listed as below:

- 0 : The switching frequency will not be adjusted by the load of current.
- 1 : The switching frequency will be auto-adjusted according to the load of current.

【F1.23】 Number of Tolerance to Drive Fault

- a. Function: Set the number of tolerance to drive fault conditions when faults are occurred for OC, OE, GF during the certain time period. The drive will display fault message on the operation panel and restart again when the numbers of drive faults are over the designated tolerance value.
- b. When the number of tolerance is set to 0, the drive will not restart after the fault occurs.

F2 Frequency Parameters

【F2.00】 Primary Speed (Preset Speed 1)

【F2.07】 Preset Speed 8

【F2.16】 Jog Speed

a. Setting range: 0.00~400.00Hz

b. The settings are listed as below:

(I) Set the acceleration / deceleration time of multi-speed (F2.18~ F2.28)

(II) Set multi-function input terminals(F5.19~ F5.22)

c. Preset speed table

Jog speed command	Multi-speed level 3 command	Multi-speed level 2 command	Multi-speed level 1 command	Name
ON	x	x	x	Jog speed
OFF	OFF	OFF	OFF	Primary Speed (Preset Speed 1)
OFF	OFF	OFF	ON	Preset Speed 2
OFF	OFF	ON	OFF	Preset Speed 3
OFF	OFF	ON	ON	Preset Speed 4
OFF	ON	OFF	OFF	Preset Speed 5
OFF	ON	OFF	ON	Preset Speed 6
OFF	ON	ON	OFF	Preset Speed 7
OFF	ON	ON	ON	Preset Speed 8

※ “x”: Don't care.

※Jog speed has the highest priority. That is, when the jog speed is on, all other speed command are void.

※Jog speed and the multi-speed commands programmed by functions F5.19~ F5.21 to define multi-function input terminals (X1~X3) are given by input signals ON and OFF to the multi-function input terminals.

※ON: “a” contact (normal open) is set and “b” contact (normal close) is open.

OFF: “a” contact (normal open) is open and “b” contact (normal close) is set.

d. Multi-speed and acceleration/deceleration time

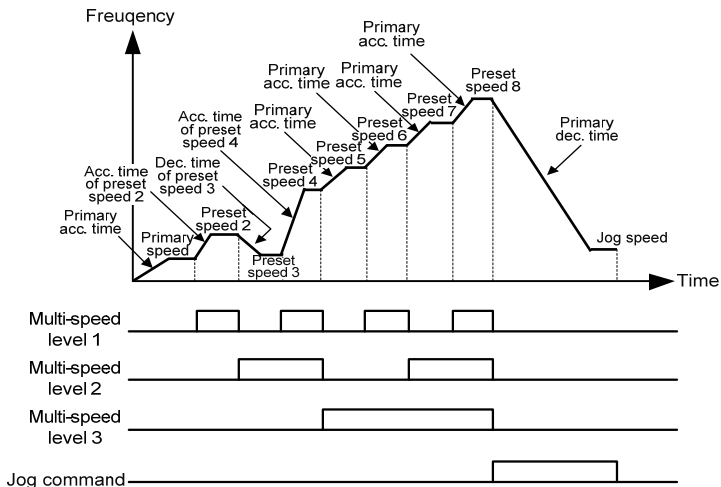

- ※The above illustration is an example of preset speed 1~8. The acceleration / deceleration time of preset speed 5~8 and jog speed are depend on the setting of primary acceleration / deceleration time.
- ※When the drive stops, and the jog command is ON, the motor is running at the jog speed – no start command is required.
- ※The analog input terminals (“Pot knob”, AI) are disabled at multi-speed setting (primary speed excluded).
- ※As for the accel/decel time, please see the parameter setting (F2.18~ F2.21).

【F2.17】 Reference Frequency of Acceleration/Deceleration Time

Set the corresponding frequency of accel/decel time.

The setting range: 0.01~400.00Hz

【F2.18/F2.19】 Primary Acceleration / Deceleration Time

【F2.24/F2.25】 Acceleration / Deceleration Time of Preset Speed 4

【F2.26/F2.27】 Secondary Acceleration / Deceleration Time

- a. The acceleration/deceleration time of preset speed is the time that the frequency starting from 0Hz accelerates to the reference frequency of acceleration/deceleration time (F2.17). Multi-speed command can control the multi-speed and acceleration/ deceleration time of preset speeds. The setting range: 0.0~3200.0 sec.
- b. The acceleration/deceleration time setting of primary speed, preset speed 5 ~ preset speed 16, and jog speed are set by primary acceleration/deceleration time (F2.18/F2.19).

- c. The secondary acceleration/deceleration time has the higher control priority, and the command is input by the multi-function input terminals.

The illustration is shown as below:

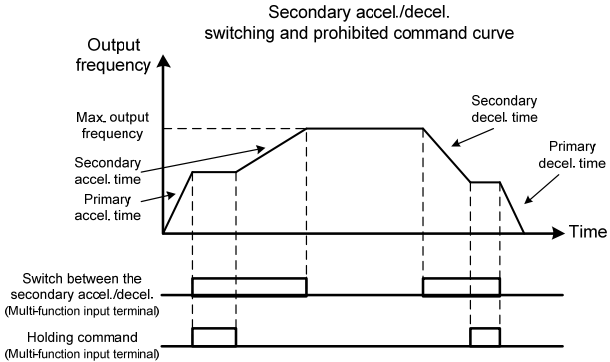

- d. The prohibition of acceleration/deceleration command are ineffective at the STOP command.

【F2.28】 Set S-curve for Accel/Decel Time

Setting the S-curve for the acceleration/deceleration time is to slow the acceleration and deceleration time at start and stop. For example: To ease the impact of the fallen object on the conveyor line or elevator.

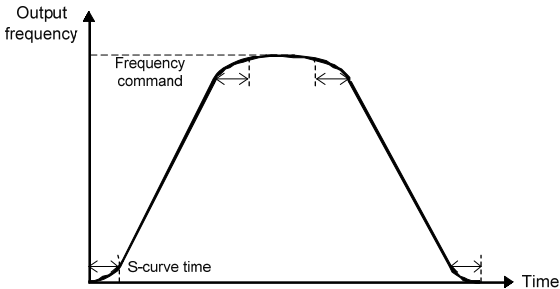

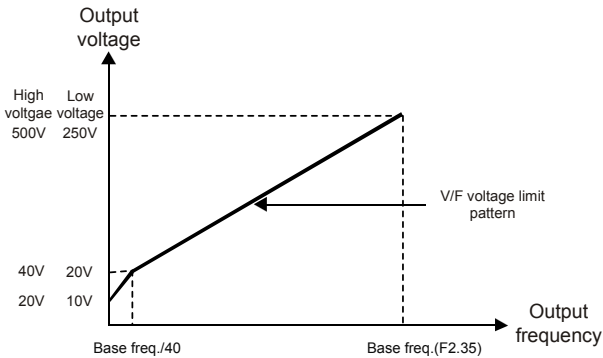

【F2.31】 V/F Pattern Selection

a. The settings are listed as below:

- 0: Linear
- 1: Energy saving mode (Auto-adjust V/F according to the loads)
- 2: Square curve
- 3: 1.7th power curve
- 4: 1.5th power curve

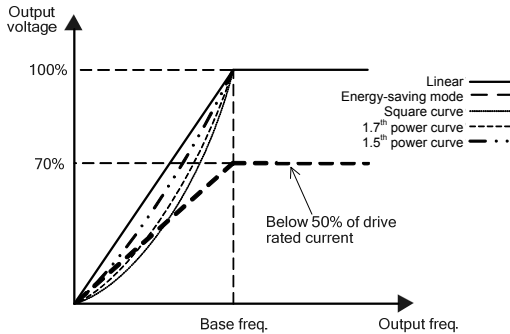

b. F2.31 = 1; When the load current is small, auto-adjusting the output voltage of drive can save the energy.

c. F2.31 = 2 ~ 4 can be used for fan, pump applications to save the energy.

【F2.32】 Maximum Output Frequency

Set the maximum operation frequency of the drive, and the setting range is 0.1~400.00Hz

【F2.33】 Starting Frequency

Set the starting frequency of the drive, and the setting range is 0.1~10.0Hz

【F2.34】 Starting Voltage

Set the output voltage of starting frequency to give more power to overcome the load inertia.

100V/200V series range: 0.1~50.0V

400V series range: 0.1~100.0V

【F2.35】 Base Frequency

Motor's base frequency. Set the frequency bases on the nameplate of motor. The setting range: 0.1~400.00Hz

【F2.36】 Base Voltage

Set the base voltage bases on the nameplate of motor.

100V/200V series range: 0.1~255.0V

400V series range: 0.1~510.0V

【F2.37】 V/F Frequency 1

Frequency at the first point of V/F pattern. The setting range is 0.0~399.9Hz

【F2.38】 V/F Voltage 1

Voltage at the first point of V/F pattern

100V/200V series range: 0.0~255.0V

400V series range: 0.0~510.0V

【F2.39】 V/F Frequency 2

Frequency at the second point of V/F pattern(refer to the setting of F2.37)

【F2.40】 V/F Voltage 2

Voltage at the second point of V/F pattern(refer to the setting of F2.38)

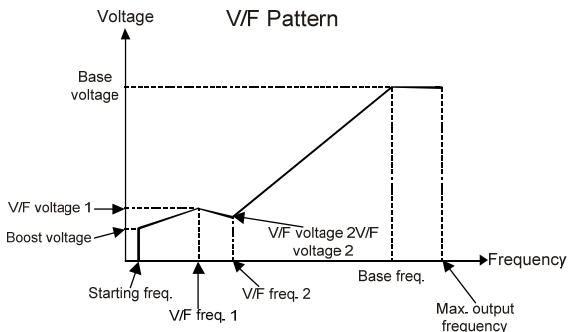

※ The interrelationships are as follows:

- (I) Base frequency > V/F frequency 2 > V/F frequency 1 > Start frequency
- (II) V/F frequency 2 < V/F frequency 1, the V/F frequency (voltage) 2 have no effect
- (III) When V/F frequency 1 and 2 < Starting frequency, the V/F frequency (voltage) 1 and 2 have no effect
- (IV) No limitation between F2.34, F2.36, F2.38, F2.40

【F2.42】 Jump Frequency 1



【F2.44】 Jump Frequency 3

In order to avoid the mechanical resonance, these parameters allow resonant frequency to be jumped. The setting range is 0.0~400.00Hz

【F2.45】 Jump Frequency Range

There are three sets of jump frequency and one type of jump frequency interval. The setting range is 0.0~25.5Hz

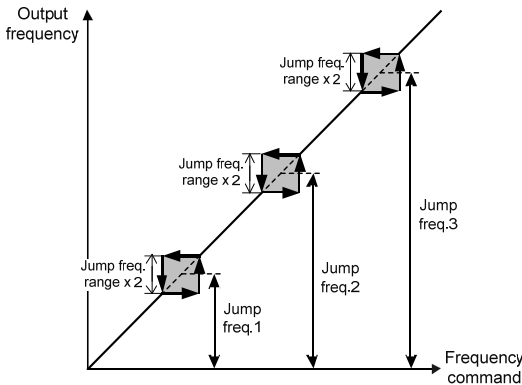

【F2.47】 Frequency Upper Limit

Set the ratio of the frequency upper limit (1.00=maximum output frequency), and the setting range is 0.00~1.00

Output frequency upper limit = Frequency upper limit (F2.47) × Maximum output frequency (F2.32)

【F2.48】 Frequency Lower Limit

Set the ratio of the frequency lower limit (1.00=maximum output frequency), and the setting range is 0.00~1.00

Output frequency lower limit = Frequency lower limit (F2.48) × Maximum output frequency (F2.32)

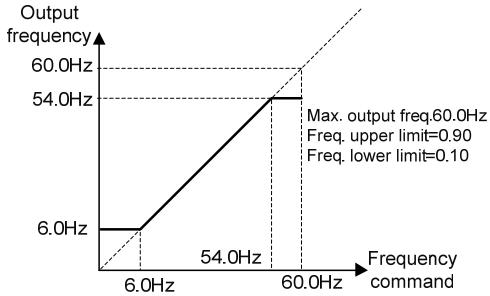

F3 Control Parameters

【F3.00】 Holding Frequency

The drive accelerates to the holding frequency and then operating in constant speed. The setting range is 0.00~400.00Hz

【F3.01】 Holding Time Interval

The operation time of drive running at the holding frequency, and the setting range is 0.0~360.0sec. Using the frequency setting and holding time is to prevent the over slip of motor causing over-current and stall.

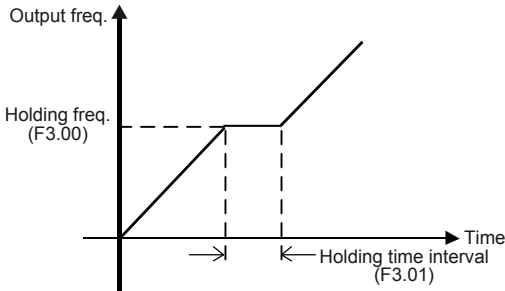

【F3.03】 Stall Prevention Level at the Acceleration

If stall is occurred during acceleration, the motor keeps running at the constant speed (200%: Off), and the setting range is 30%~200% of drive's rated current

【F3.04】 Stall Prevention Level at the Constant Speed

If stall is occurred at constant speed running, the motor decelerates (200%: Off), and the setting range is 30%~200% of drive's rated current

【F3.05】 Acceleration Time for Stall Prevention at the Constant Speed

Setting the acceleration time for the stall prevention of the constant speed, and the setting range is 0.1~3200.0 sec.

【F3.06】 Deceleration Time for Stall Prevention at the Constant Speed

Setting the deceleration time at the stall prevention of the constant speed, and the setting range is 0.1~3200.0 sec.

【F3.07】 Deceleration Stall Prevention

0: Deceleration stall prevention: Disabled

1: Deceleration stall prevention: Enabled

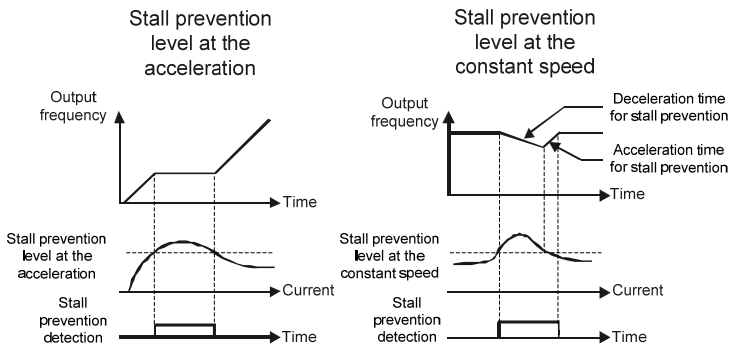

- The function of the stall prevention during the deceleration is to maintain a constant speed when the deceleration is stalling.
- When connecting a dynamic brake unit, F3.07 function can be disabled according to the operation requirement
- If the DC bus voltage of the drive is higher than the dynamic brake voltage level when drive stops, the operation panel or external keypad will display "Hv". "RUN" key of the operation panel and digital keypad can't start the drive. If the DC bus voltage is less than the dynamic brake voltage level, the drive will be automatically recovered and the display will be back to the main display.

【F3.09】 Motor Slipcompensation

- The slip of motor is variable depending on the load. When the load current is over the level of slip compensation, the drive will compensate the output frequency to output constant speed. The setting range is -59.9~60.0Hz.
- Compensation frequency:

$$\text{Freq. compensation} = \frac{\text{Loading current} - (\text{no load current (F4.09)})}{\text{Rated current(F4.08)} - (\text{no load current (F4.09)})} \times \text{Slip compensation(F3.09)}$$

【F3.10】 Frequency Response Time of Motor Slip Compensation

- Setting the frequency response time of motor slip compensation. The unit is 5ms.
- Decreasing the setting value when the response time is too slow. When the response time of motor slip compensation is too fast causing the rotational speed unstable, increasing the setting value. The setting range is 1~255

【F3.18】 Automatic Voltage Regulation (AVR)

- Function: When the power source is fluctuation, the drive will adjust output voltage automatically to stabilize the V/F output control.
- When AVR is set to "0", the reference voltage bases on the setting of power source voltage (F0.05).

c. Setting range: 0: Disable 1: Enable

【F3.19】 Response Time of AVR

Set the response time of AVR. The setting range is 0~255.

【F3.21】 DC Braking Level

- Set the current level of DC braking.
- The setting range is 0~150% of drive rated current.

【F3.22】 DC Braking Response Time

According to the DC braking conditions to adjust the response time. The setting range is 0~255.

【F3.23】 Time Interval of DC Braking at Start

Set the DC braking for motor random running at start. The setting range is 0.0~60.0.

【F3.24】 Time Interval of DC Braking at Stop

- The setting of time interval of DC braking is to avoid inertial run of motor at stop.
- Set the DC braking of ramp to stop. The setting range is 0.0~60.0 sec.

【F3.25】 DC Braking Frequency at Stop

- Set the DC braking frequency at stop. The setting range is 0.1~60.0.
- If changing the setting value of frequency below the starting frequency(F2.33), the drive will stop by DC braking, and the DC Braking Frequency at Stop(F3.25) will be not active.

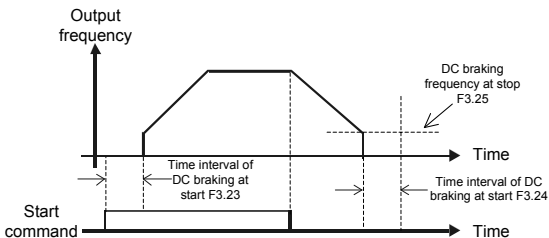

【F3.30】 Operation Selection at Instantaneous Power Failure

a. The settings are listed as below:

- 0: Drive cannot be restarted at instantaneous power failure.
- 1: Drive can be restarted at instantaneous power failure.
(see the function description of the restart after instantaneous power failure detection of multi-function output setting (F5.26))
- 2: Ramp to stop

- 3: When the power is restored during the ramp to stop interval, the drive is restarted and re-accelerated again.
- b. The drive cannot be started with generator power restart simultaneously at power off. The drive must be started after the generator restarts.
 - c. The ramp to stop function is applicable for the inertial load. Adjusting setting values of functions F3.32~F3.34 can make re-regenerative energy from motor during the motor ramp to stop feedback to the drive; meanwhile, the motor decelerates to stop.

【F3.31】 The voltage Level Setting at Power Failure

- a. When the voltage level of power source is lower than the voltage level setting of F3.31, the motor will be decelerating for ramp to stop.
- b. The settings are listed as below:
 - 100V series range: 75.0~96.0V
 - 200V series range: 150.0~192.0V
 - 400V series range: 300.0~384.0V

【F3.32】 Subtracted Frequency of Deceleration at Power Failure

- a. When the motor is decelerating for ramp to stop during the power failure, the output frequency=drive's original output frequency – subtracted frequency(F3.32)
- b. Setting range: 0.0~20.0Hz.

【F3.33】 Deceleration Time 1 at Power Failure

Set the deceleration time when the drive output frequency is greater than turning frequency (F3.35). Setting range: 0.0~3200.0sec.

【F3.34】 Deceleration Time 2 at Power Failure

Set the deceleration time when the output frequency is less than turning frequency (F3.35). Setting range: 0.0~3200.0sec.

【F3.35】 Turning Frequency at Power Failure

Set the turning frequency for the two sections of deceleration time is to set the turning point of two deceleration operations(F3.33 and F3.34).
Setting range: 0.0~400.00Hz.

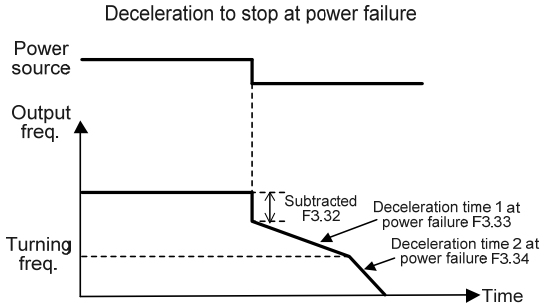

【F3.37】 The Current Level of Speed Tracing

- a. When the drive current is greater than the current level of speed tracing (F3.37), the output frequency is tracing downwardly to reach the current level of speed tracing. The setting range is 0~200% of drive rated current.
- b. The speed tracing function is mainly used for tracing the speed for the drive restart after instantaneous power failure/flying start, the drive fault restart, or the speed tracing command is given by the input terminal.
- c. See the function description of F5.19~F5.22 multi-function input terminals for speed tracing.

【F3.38】 Delay Time for Speed Tracing

Set the output delay time before the speed tracing.
The setting range is 0.1~60.0 sec.

【F3.39】 The V/F Pattern of Speed Tracing

Set the percentage of V/F output voltage for the speed tracing.
The setting range is 0~100%.

F4 Protection Parameters

【F4.07】 Motor Overload Protection (OL)

- a. The motor overload protection is listed as below :
- 0: Motor overload protection: Disabled
 - 1: Motor overload protection: Enabled (OL)
 - 2: Motor overload protection of motor independent cooling fans: Enabled (OL)
- b. Motor overload protection is to avoid the motor operating in the overload condition for a long time causing damages to motor. Disabling the motor overload protection may possibly damage the motor.

【F4.08】 Motor Rated Current

Motor rated current : Bases on the motor nameplate to set the value of F4.08. The setting range: 10~150% of drive rated current ; Unit: Amp.

【F4.09】 Motor No-Load Current

Motor No-Load Current: about 1/3 of motor rated current. The setting range: 0~motor rated current ; Unit: Amp.

【F4.10】 Trip Time of Motor Overload

- a. When the drive output current is over the motor rated current (F4.08), OL protection is activated for trip time counting (F4.10).
- b. The drive output current reaches 150% of the motor rated current (F4.08) and continuously operates over the setting time(F4.10), the drive trips to OL protection.
- c. This function is to set the protection time when motor is overloaded. The setting range: 0.5~10.0 min.

【F4.12】 Protection Level of Drive Overheat

The heat sink protection level of the drive reaches the protection level (F4.12), the drive trips to OH protection. The setting range is 85~115°C.

【F4.13】 Drive Overheat Pre-alarm Selection

- a. The settings are listed as below:
- 0: Disable
 - 1: Warning (OHt): Continuous operation. (relay terminal outputs)
 - 2: Warning (OHt): Drive de-rates the switching frequency automatically every 5 minutes. (relay terminal outputs).
 - 3: Warning (OHt): Drive trips to "OHt" protection and stop, and the cooling fans activate. After the temperature decreases lower than "drive overheat dead band (F4.15)", drive starts to operate again. (relay terminal outputs)
- b. For relay terminal outputs, please see the function setting F5.26

【F4.14】 Drive Overheat Pre-alarm Level

Set the overheat pre-alarm level (OHt) of drive. The temperature of drive will

increase when the cooling fans is damage or the heat sink is covered by foreign objects. User can maintain the cooling fans of drive in advance. The setting range is 45~105°C

【F4.15】 Drive Overheat Dead Band

When the drive heat sink temperature is over the pre-alarm level, the drive displays “ Oht ” until the temperature drops below the drive overheat dead band (F4.15).

The setting range: 0.1~10°C

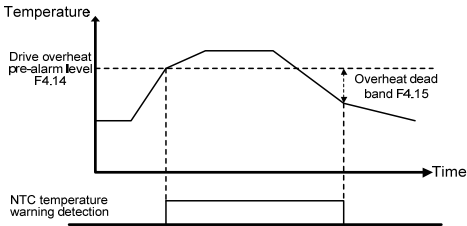

【F4.17】 Fan Control Selection

a. Function: Increase the lifetime of drive cooling fans, save energy and extend the maintenance cycle time of heat sink.

b. The settings are listed as below:

0: Forced air cooling

Start and continuously operate the cooling fans of drive when power ON.

1: Operation air cooling

Cooling fans of drive is start when the drive is operation. Cooling fans will stop when the drive disable and after waiting at the minimum operation time (F4.19).

2: Temperature control

Drive cooling fans activate when the drive temperature is over the temperature level of fan activation (F4.18). Cooling fans will stop when the temperature of drive drops below the overheat dead band of drive(F4.15) after waiting at the minimum operation time (F4.19).

【F4.18】 Temperature Level of Fan Activation

Set the temperature level for drive cooling fans startup, and the setting range is 25~60°C

【F4.19】 Minimum Operation Time of Fan

Set the minimum operation time of drive cooling fans activation, and then according to the setting of F4.17 to set the operation method of cooling fan. The setting range is 0.1~25 min.

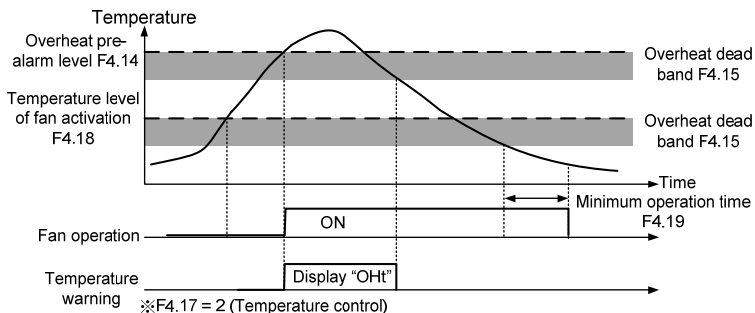

【F4.25】 System Overload Detection(OLO)

a. The settings are listed as below:

0: Disable

1: Enable (OLO)

b. System overload detection is to prevent the system from any possible damages caused by system overload. The detection level (F4.28) and time (F4.29) can be set based on operation requirements.

【F4.26】 System Overload Detection Status

The settings are listed as below:

0: Detection at constant speed only.

1: Detection at operation: Including the system overload at acceleration, deceleration or constant speed.

【F4.27】 Output Setting of System Overload

The settings are listed as below:

0: Drive continues running after the system overload is detected

1: Drive trips after the system overload is detected.

【F4.28】 System Overload Detection Level

Setting the level of current for system overload detection, and the setting range is 30~200% of drive rated current.

【F4.29】 System Overload Detection Time

a. The detection of system overload is shown in the below chart:

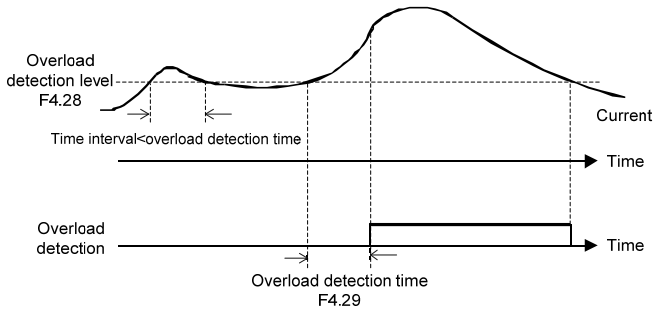

b. The operation panel displays “OLO”, when the system overload time is over the setting value of system overload detection time (F4.29).

c. Setting range: 0.1~300.0sec.

F5 Multi-function Parameters

【F5.00】 “Pot knob” Selection (Analog Input)

The settings are listed as below:

- 0: Analog input gain
- 1: Frequency command
- 2: Current limit
- 3: Variable voltage of V/F pattern

【F5.01】 Analog Input AI Selection

The settings are listed as below:

- 0: Analog input gain
- 1: Frequency command
- 2: Current limit
- 3: Variable voltage of V/F pattern
- 4: PTC temperature
- 5: PID feedback

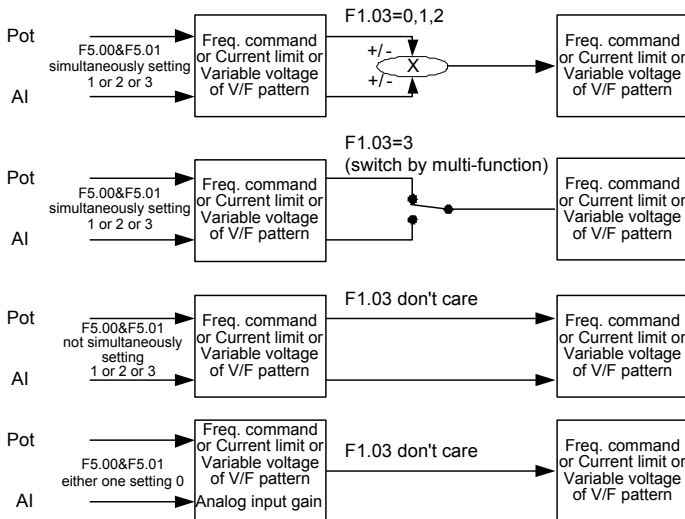

※When F1.01 is set to “0”, the frequency command inputs from analog input terminals, function F5.00 or F5.01 must set to “1”; otherwise, the frequency command is 0.0Hz.

※When F5.00 and F5.01 are simultaneously setting 1 or 2 or 3, the function F1.03 = 0 or 1 or 2 will be activated.

※When F5.00(F5.01) is set to “0”, the gain adjustment must be with F5.00(F5.01)=1 or 2 or 3.

【F5.02】 AI Input Source Selection

a. The settings are listed as below:

0: DC 4~20mA(2-10V)

1: DC 0~20mA(0-10V)

b. AI-GND analog input terminal

(1) Insert JP1 jumper to V position

The range of AI is 0~10V or 2~10V; Range is set by function F5.02

(2) Insert JP1 jumper to I position

The range of AI is 0~20 mA or 4~20mA; Range is set by function F5.02

【F5.03】 “Pot knob” Gain (Analog Input)

The “Pot knob” gain range setting, and the setting range is 0.00~2.00.

【F5.04】 “Pot knob” Bias (Analog Input)

The “Pot knob” bias range setting, and the setting range is -1.00~1.00.

【F5.05】 AI Gain (Analog Input)

The AI gain range setting, and the setting range is 0.00~2.00.

【F5.06】 AI Bias (Analog Input)

The AI gain range setting, and the setting range is -1.00~1.00.

a. Analog input terminals:

1. Pot knob

2. AI – GND 4~20mA(2~10V) or 0~20mA(0~10V)

b. Max. frequency command= Max. output frequency x Analog input gain
(F2.32) (F5.03 or F5.05)

c. Freq. bias value= Max. output frequency x Analog input bias
(F2.32) (F5.04 or F5.06)

d. Frequency command:

$$\text{Freq. command} = \frac{\text{Analog command}}{10\text{V (or } 20\text{mA)}} \times (\text{Max. freq. command} - \text{freq. bias}) + \text{freq. bias}$$

Example: Analog input bias= 0.00

Max. output frequency= 60.0Hz

Analog input gain= 1.20

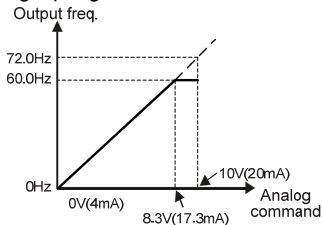

Max. output frequency= 60.0Hz

Analog input gain= 0.80

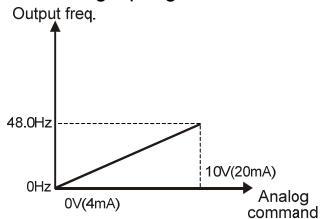

Example: Analog input gain= 1.00

Max. output frequency= 60.0Hz
Analog input gain= 0.05

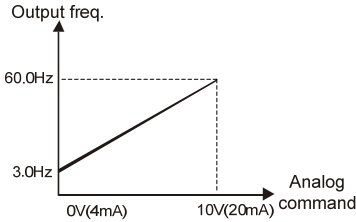

Max. output frequency= 60.0Hz
Analog input gain= -0.05

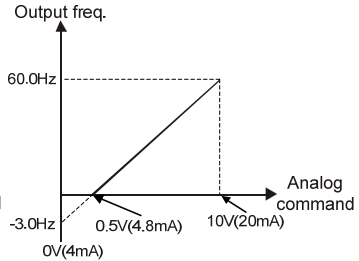

Example: Inverse control application

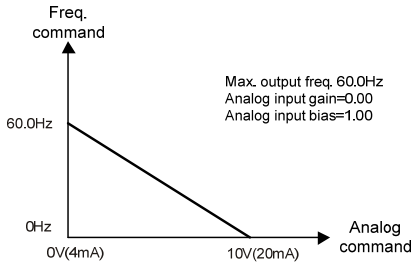

【F5.07】 Filter Setting of Analog Frequency

- a. "Pot knob" or AI is set for frequency command control (F1.01=0): signal filtering
- b. Higher setting value of F5.07 reacts to the slow response. F5.07 = 0: no filtering. The setting range is 0~255.

【F5.19】 Multi-function Input Terminal X1

【F5.21】 Multi-function Input Terminal X3

- a. "+" represents a contact(normal open)
"-" represents b contact(normal close)
- b. The settings of multi-function terminals X1 ~X3 are listed as below:
 - ±1: Jog command (see the function descriptions of F2.16)
 - ±2: Secondary acceleration / deceleration command switching(see the function description of F2.26 and F2.27)
 - ±3: Multi-speed level 1 command(see the function description of F2.00 ~ F2.07 for multi-speed setting)
 - ±4: Multi-speed level 2 command(see the function description of F2.00 ~ F2.07)

- for multi-speed setting)
- ±5: Multi-speed level 3 command(see the function description of F2.00 ~ F2. 07 for multi-speed setting)
- ±7: Reset command
Setting the reset command to reset the drive fault.
- ±8: External fault command (EF)
Drive in operation: accept the external fault command to trip the drive.
Drive stop: Disable

±9: Interruption of output command (bb)
 Interrupt the output voltage of the drive

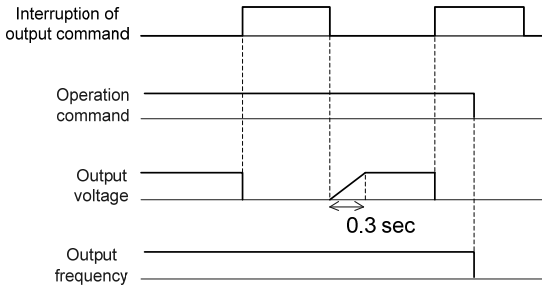

±10: Coast to stop command(Fr)
 Interrupt the drive output voltage immediately

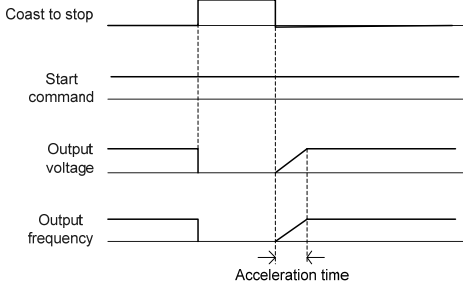

±11: Speed search from the maximum frequency

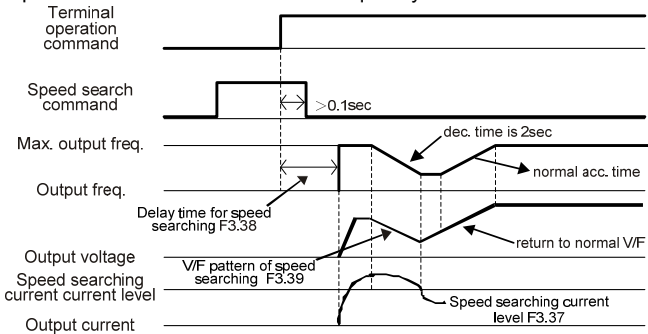

±12: Speed search from the frequency setting

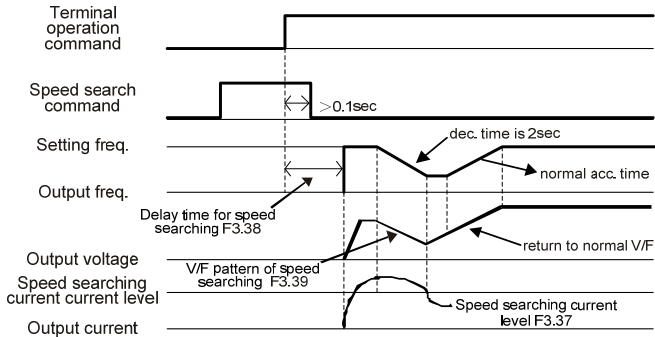

±13: Holding command(refer to the description of multi- acc/dec time)

±14: UP command

Frequency setting stepping increase

±15: DOWN command

Frequency setting stepping decrease

±16: Clean UP/DOWN frequency command

The frequency command is cleaned to 0.00Hz

±17: UP/DOWN command enter key

- (1) Setting the UP/DOWN command enter key for multi-function input terminals X1~X4. UP/DOWN command enter key must be set to activate UP/DOWN command (±14 and ±15) when one of multi-function input terminals X1~X4 is defined as UP/DOWN command enter key.

Open (Multi-function Input Terminal): UP/DOWN commands to change the input frequency command and the output frequency is not changed with the variation of frequency commands.

Short (Multi-function Input Terminal): The output frequency accelerates/decelerates to the frequency command setting.

- (2) If one of multi-function input terminals X1~X4 is not defined as UP/DOWN command enter key, the drive output frequency is controlled by UP/DOWN command.

±18: Analog input source selection("Pot knob"/AI)

Setting the function F1.03 (Analog Input Selection) to 3 ("Pot knob" or AI)

Set to 18	a contact ; "Pot knob" is the analog input source
	b contact ; AI is the analog input source
Set to -18	a contact ; AI is the analog input source
	b contact ; "Pot knob" is the analog input source

±19: Primary and secondary frequency command option

Set to 19	a contact ; The frequency command = Primary frequency command(F1.01)
	b contact ; The frequency command = Secondary frequency command(F1.02)
Set to -19	a contact ; The frequency command = Secondary frequency command(F1.02)
	b contact ; The frequency command = Primary frequency command(F1.01)

±20: Start command of sequential operation control

When the function F6.00 is not set to 0 (sequential operation control) and the start command of sequential operation control sets ON, the drive output frequency is based on the frequency command setting of sequential operation control for the drive operation. If the start command of sequential operation control is set to OFF, the sequential operation control stops.

±21: Pause command of sequential operation control can temporarily pause the drive operation during sequential operation control. After pause command is clear, drive operation continues with sequential operation control.

±22: Forward command

See the function setting of F1.00 for setting forward command.

±23: Reverse command

See the function setting of F1.00 for setting reverse command.

±24: Stop command of 3-wire start/stop circuit

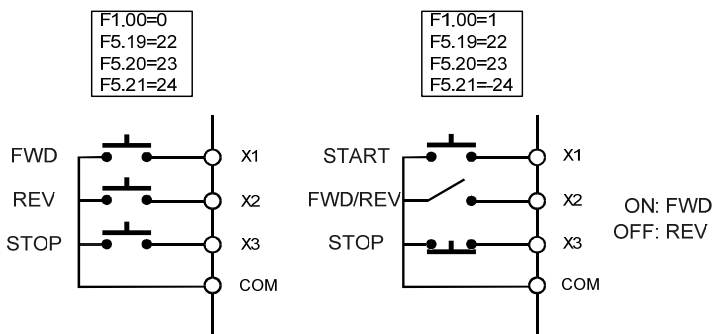

±25: DC braking enable (Stop)

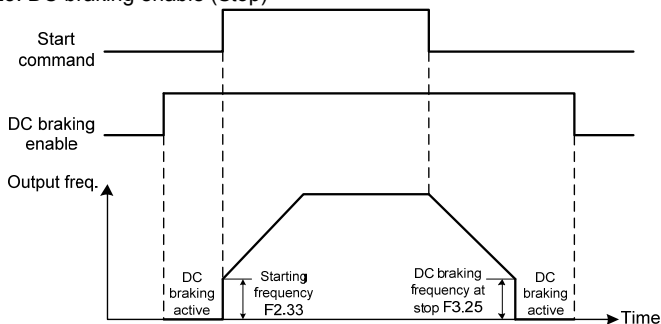

- (1) When the drive stops and DC braking command is ON, DC braking is active to stop the motor.
- (2) The setting value of output current must be according to the function setting of F3.21, when the DC braking is active.
- (3) When the start or jog command is active, DC braking command will be clear, and the motor will run to the setting frequency.
- (4) The drive output frequency decreases to the setting value of F3.25(DC Braking Frequency at Stop) when the start or jog command is inactive.

±26: Counter input

- (1) Using external triggering signal from multi-function input terminal to activate drive counter function.
- (2) Selecting the input voltage of counter between 4V and 13V.
- (3) External triggering signal: the signal can be from optoelectronic sensor or approximate switch to drive

±27: Counter clear

Clear the counting value

±28: Current limit enable

- (1) The multi-function input terminal is activation and either F5.00 or F5.01 is set to 2.
 - a. Current limit enable
 - b. Monitoring the value in the monitor mode(range: 1~150).
- (2) Multi-function input terminal inactive
 - a. "Current limit enable" is disable.
 - b. The setting value is same as function F3.04 (range: 30~200) in the monitor mode.

【F5.25】 Digital Input Response Time

- a. Setting the input response time of multi-function terminals (X1~X3) .(digital debouncing)
- b. If the signal length of digital inputs is smaller than the digital input response time, drive software will reject the input signal and do no process to input signal.

【F5.26】 Multi-function Output Setting of Y1 Terminals

- a.Y1:NPN type output terminals.
- b.“+”: Represents a contact (normal open),
“-”: Represents b contact (normal close)
- c. Setting the function for output terminals Y1 is listed as below:
 - ±1: Running detection
Detection at drive start
 - ±2: Constant speed detection
Detection at constant speed
 - ±3: Zero speed detection
Detecting at drive zero speed and no detect during the DC braking.
 - ±4: Frequency detection

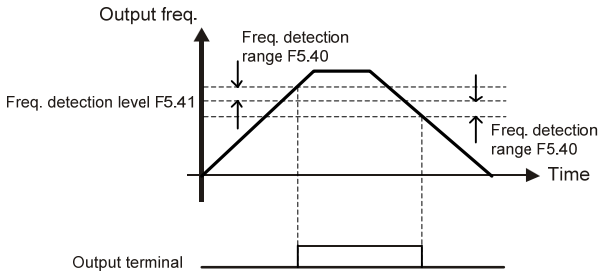

±5: Overload detection(OLO)

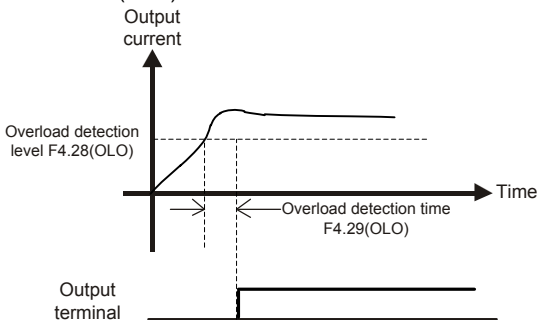

±6: Stall prevention detection

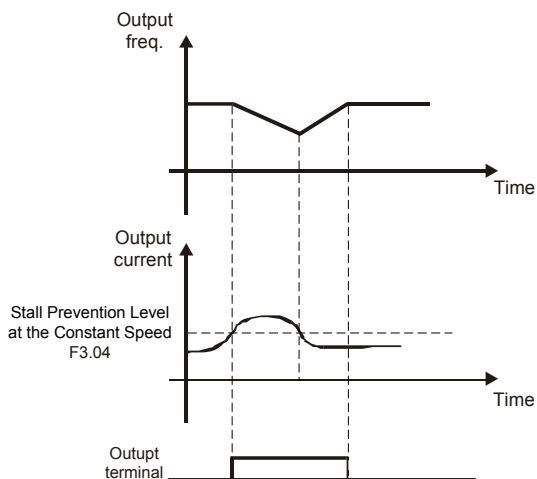

±7: Low voltage detection(LE)

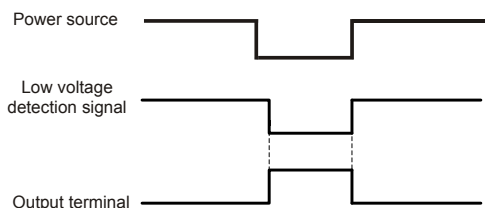

±8: Braking transistor is active detection(db)

Detection when the DC bus voltage of drive is higher than the dynamic brake voltage.

±9: Restart after instantaneous power failure detection
Enable when F3.30 is set to 1.

Restart after instantaneous power failure detection

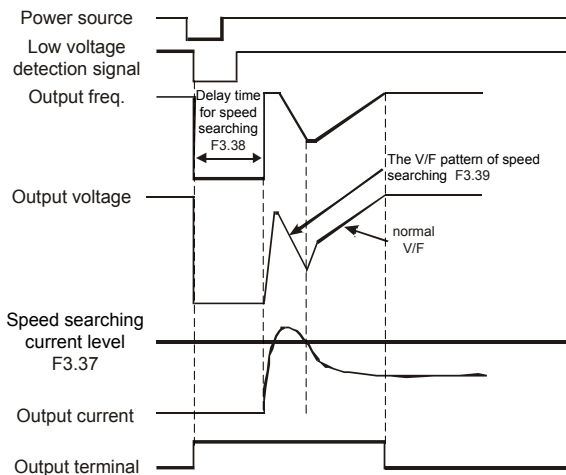

±10: Restart after fault condition detection

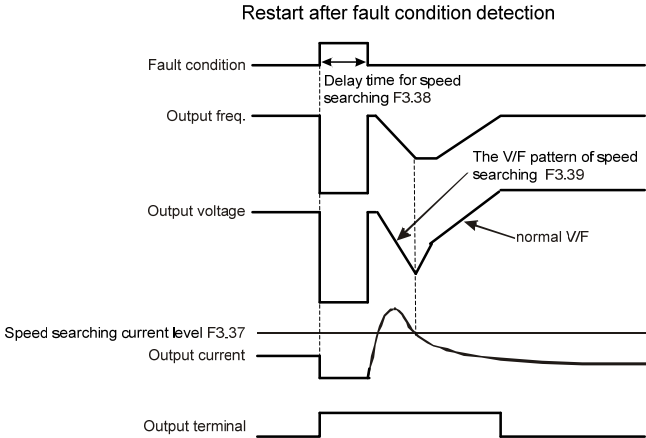

±11: Fault detection

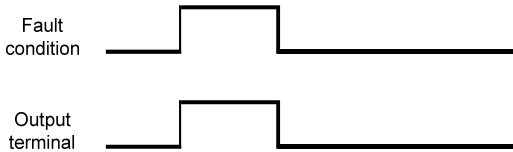

±12: Start detection of sequential operation control
 Detection when sequential operation control starts.

±13: One complete operation sector detection of sequential operation control
 After one complete operation phase of sequential operation control, Ta/Tc terminals will output the detection signal for 0.1 seconds.

±14: One complete operation cycle detection of sequential operation control
 After one complete operation cycle of sequential operation control, Ta/Tc terminals will output the detection signal for 0.1 seconds.

±15: Pause command detection of sequential operation control
 Ta/Tc terminal outputs detection signal when the pause command is given during sequential operation control.

±16: Detection of counter value 1
 Detection when the counting value is equal to the setting value of F5.36

±17: Detection of counter value 2

Detection when the counting value is equal to the setting value of F5.37

±18: Reverse detection

Detection when the drive runs at reversed direction.

±19: NTC temperature warning detection (OHT)

Detection when the drive temperature sensed by thermal detector(NTC) is higher than the temperature warning level (F4.14).

±20: Fan operation detection

±21: PTC temperature warning detection (OH1)

Detection when the motor temperature sensed by PTC detector is higher than the PTC temperature warning level (F4.21).

【F5.30】 UP/DOWN Memory Selection

0: Erasing the frequency command setting in memory to 0.00Hz when power is interrupted.

1: Storing the frequency command setting to function F5.30 when power is interrupted.

【F5.31】 UP/DOWN Frequency Calibration

The calibrating range of frequency command of UP/DOWN command

Setting Value	Unit	The Calibrating Range of Frequency Command
0:	0.01Hz	0.01Hz
1~8:	×0.05Hz	Setting 8 to calibrate frequency command.
9:	0.05Hz	0.05Hz
10~250:	×0.1Hz	Setting 250 to calibrate frequency command.

【F5.32】 UP/DOWN Calibrating Time

1~5: The response time of terminal calibration (unit: second)

If UP/DOWN terminal (see F5.19~5.22 for UP/DOWN terminal setting) is set to ON/OFF over the response time of terminal calibration, motor will continue accelerating/decelerating to the maximum/minimum running speed (frequency) – ON for acceleration operation and OFF for deceleration operation.

6: Edge trigger

The trigger mode uses the input signal edge as the trigger signal without being controlled by the trigger response time. The signal responding time is 30ms.

【F5.33】 UP/DOWN Frequency Adjustment

Frequency command is directly adjusted by keypad. The setting value of frequency command will be stored to function F5.33 after 5 seconds when using UP/DOWN command to set the frequency command.

UP/DOWN time chart:

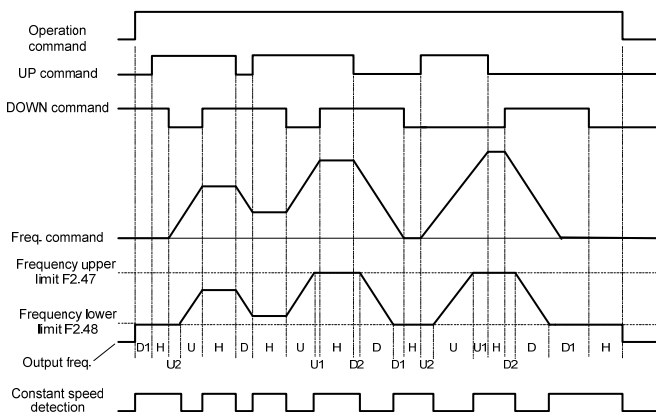

U=UP (acceleration) status
 D=DOWN (deceleration) status
 H=HOLD (constant speed) status
 U1=UP status bounded at the upper limit of the frequency
 U2=UP status bounded at the lower limit of the frequency
 D1=DOWN status bounded at the lower limit of the frequency
 D2=DOWN status bounded at the upper limit of the frequency

【F5.35】 Counting Mode

The settings are listed as below :

- 0: Up counting mode
- 1: Down counting mode

【F5.36】 Counter Value 1

Setting the number of counting value to conduct the relay outputs for 100ms; The setting of counting value: 0~9999 times(see the setting of counting value detection in 5.26).

【F5.37】 Counter Value 2

Setting the number of counting value to conduct the relay outputs until complete the cycle. The counter setting value: 0~9999 times(see the setting of counting value detection in 5.26).

Up counting mode:

F5.35=0
F5.36=500
F5.37=400

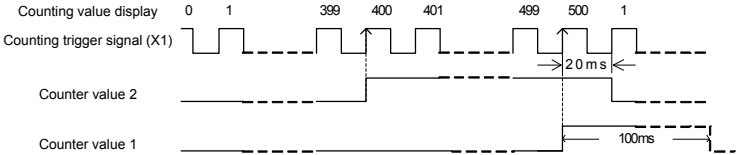

Down counting mode:

F5.35=1
F5.36=1000
F5.37=2000

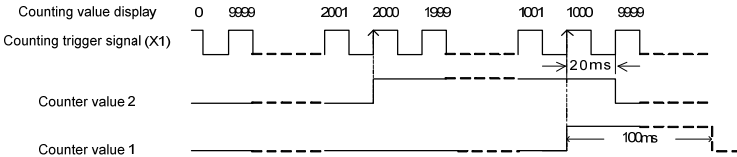

※The cycle of triggering signal cannot be less than 20ms(<50Hz)

※The detection signal of multi-function output terminal must remain at least for 100ms.

【F5.39】 Constant Speed Detection Range

Setting range: 0.0~10.0Hz; see the constant speed detection setting of multi-function output terminal (F5.26)

【F5.40】 Frequency Detection Range

Setting range: 0.0~10.0Hz; see the frequency detection setting of multi-function output terminal (F5.26)

【F5.41】 Frequency Detection Level

Setting range: 0.0~400.00Hz; see the frequency detection setting of multi-function output terminal (F5.26)

F6 Special Parameters

【F6.55】 Communication Address

- a. When using RS-485 communication interface to monitor the drive, each drive must be assigned with its communication address, and the same address number cannot be assigned to other drives once this address is defined already. Setting range: 0~254; maximum sets of drive connection: 31 sets in parallel.
- b. 00—No communication control.

【F6.56】 Baud Rate

Setting the transmission rate of communication (bps: bit/sec); The baud rate of the drive must be same as the host device for communication control.

- 0 : 4800bps
- 1 : 9600bps
- 2 : 19200bps

【F6.57】 Communication Protocol

- a. Serial communication between the host and drive is using non-synchronous data transmission. 1 frame = 11bits
[8,N,2 for RTU] : 1 start bit , 8 data bits , 2 stop bits
[8,E,1 for RTU] : 1 start bit , 8 data bits , 1 even parity bit , 1 stop bit
[8,O,1 for RTU] : 1 start bit , 8 data bits , 1 odd parity bit , 1 stop bit
- b. Please see the communication protocol of 6-3

【F6.58】 Communication Overtime (Cot)

- a. Setting the detection time when communication timeout
- b. The communication overtime happens only when the data transmission during communication transmission is interrupted, has no data transmitting, or delays. "Cot" time setting can monitor the communication status between device and can detect if there is communication failure.
- c. The settings are listed as below:
 - 0.0: Communication overtime detection disabled
 - 0.1~100.0: Setting the detection time to detect the communication linking status between drive and host device.

【F6.59】 Communication Overtime Disposal

Setting the disposal of drive when communication overtime.0: Warning (Cot): Continue operation.

- 1: Warning (Cot): Ramp to stop
- 2: Warning (Cot): Coast to stop

※Start command is required to restart the drive after the drive is completely stopped.

※The overtime warning display will automatically disappear after the communication is uplinked and functional again.

【F6.60】 Multi-Function Input Selection

The settings are listed as below:

0: Multi-function inputs from multi-function terminals

1: Multi-function inputs from communication control

Chapter 6 Communication Description

6-1 Modbus Port (RJ-45)

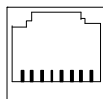

8 ← 1

Type	Pin	Function	Description
Modbus(RS-485) communication	1	Communication transmission terminal (DX+)	Differential input of RS-485 *Note 1
	2	Communication transmission terminal (DX-)	Modbus (RS-485) communication only uses pin1, 2.
	3-8	Reserved	Reserved

Note 1: The terminal resistor(100Ω) selection is set by DSW1(Default setting: ON)

Note 2: When using multiple sets of drive, connect all the DX+, DX- terminals of each drive by series, and connect the shielded net of the connection wire to FG terminal.

Note 3: The function of terminal resistor is to terminate the electric signal and avoid the reflective signal to interfere the signal. Switch DSW1 to "ON" position of the first and last drive and switch to "1" position for other drives. The default value is "ON" position.

Note 4: The cable length from the controllers(PC, PLC) to the last drive cannot exceed 500m.

Note 5: Max. controller number are 31 sets.

6-2 The Setting of Communication Parameter

- F6.55 Communication Address : 00~254 (00—Disable)
- F6.56 Baud Rate :
 - 0: 4800bps
 - 1: 9600bps
 - 2: 19200bps
- F6.57 Communication Format :
 - 0: 8,N,2 for RTU
 - 1: 8,E,1 for RTU
 - 2: 8,O,1 for RTU
- F6.58 Communication Overtime (Cot) :
 - 0.0: No overtime detection
 - 0.1~100.0sec: The setting of overtime detection
- F6.59 Communication Overtime Disposal :
 - 0: Warning (Cot): Continue operation
 - 1: Warning (Cot): Ramp to stop
 - 2: Warning (Cot): Coast to stop
- F6.60 Multi-Function Input Selection :
 - 0: Multi-function inputs from multi-function terminals
 - 1: Multi-function inputs from communication control

6-3 Communication Protocol

Serial data transmission is an asynchronous serial data transmission: 1 frame = 11 bits (3 types of format shown in below figures)

- 8,N,2: 1 start bit · 8 data bits · 2 stop bits

START	BIT 0	BIT 1	BIT 2	BIT 3	BIT 4	BIT 5	BIT 6	BIT 7	STOP	STOP
-------	-------	-------	-------	-------	-------	-------	-------	-------	------	------

- 8,E,1: 1 start bit · 8 data bits · 1 even parity bit · 1 stop bit

START	BIT 0	BIT 1	BIT 2	BIT 3	BIT 4	BIT 5	BIT 6	BIT 7	EVEN PARITY	STOP
-------	-------	-------	-------	-------	-------	-------	-------	-------	----------------	------

- 8,O,1: 1 start bit · 8 data bits · 1 odd parity bit · 1 stop bit

START	BIT 0	BIT 1	BIT 2	BIT 3	BIT 4	BIT 5	BIT 6	BIT 7	ODD PARITY	STOP
-------	-------	-------	-------	-------	-------	-------	-------	-------	---------------	------

6-4 Message Format

Address (Drive)	OP Code	Data n	...	Data 1	Data 0	CRC 0	CRC1	END
Drive Address No. (1 Byte)	Operation Message (1 Byte)	Data Message (Data length "n": depending on OP Code)				CRC Checksum		No Transmitting ≥ 10 ms

- **Address:** Drive address number for host to control

 - 00H:** The host broadcasts messages to all receivers (drives). All receivers only receive the message but has no messages returned to the host.
 - 01H~FEH:** The host designates the receiver (drive) by defining the drive address number.
- **OP Code(Operation Code):** The operation of the host to the drive

 - 03H-** Read multi-registers
 - 06H-** Write to single register
 - 08H-** Receiver detection
 - 10H-** Write to multi-registers
- **Data:** Including start register, several registers, data length (maximum 8 data), data content (maximum 16 bits)

Note: Data length – 1 byte, others – 1 word(2 bytes)
- **CRC Checksum:** Cyclical Redundancy Check performs XOR and bit shifting operations for all hexadecimal values in the message to generate the checksum code to verify the communication validity. Checksum is to sum all message bits for 16-bit CRC calculations. (See CRC Checksum)
- **Message Length:** Message length is listed in between maximum and minimum values. Message lengths of OP code 03H and 10H are dependent on the number of registers required in one message. (See Operation Code(OP Code) Description)

OP Code	Description	Instruction Code		Return Code	
		Min(bytes)	Max(bytes)	Min(bytes)	Max(bytes)
03H	Read multi-registers	8	8	7	21
06H	Write to single register	8	8	8	8
08H	Drive Detection	8	8	8	8
10H	Write to multi-registers	11	25	8	8

●**Operation Code(OP Code) Description:**

※**03H (Read multi-registers):**

Example: Read data from registers 2101H and 2102H of the drive 1

Message Code (Host to Drive)

Address	OP Code	Starting Register		Register Numbers to Readout		CRC Checksum	
		MSB	LSB	MSB	LSB	LSB	MSB
02H	03H	21H	01H	00H	02H	9FH	C4H

This example shows the host to read the drive data from 2 registers of the drive. The host identifies drive 1 by calling the drive address (02H) with the “read” operation command (03H) to read the drive data from the registers (2101H – starting register) to the register (2102H – Register Numbers to Readout defines the numbers of register for data readouts).

Return Code (Drive to Host)

Address	OP Code	Data Bytes	2101H(Register) Data		2102H(Register) Data		CRC Checksum	
			MSB	LSB	MSB	LSB	LSB	MSB
02H	03H	04H	55H	00H	17H	70H	D6H	EBH

The host reads registers 2101H and 2102H of drive (02H) (drive status and speed command). After the drive receives the host’s command, the drive returns 4 bytes data (2101H=5500H and 2102H=1770H) to the host.

Caution: The host cannot simultaneously broadcast 03H OP code to drives when multiple drives connected or all drives reject host’s OP code.

※**06H (Write to single register)**

Example: Write a data (1770H) into the drive register (2001H)

Message Code (Host to Drive)

Address	OP Code	Drive Register		Register Data		CRC Checksum	
		MSB	LSB	MSB	LSB	LSB	MSB
02H	06H	20H	01H	17H	70H	DDH	EDH

This example shows the host to write the data (1770H) to the register (2001H) of the drive. The host identifies drive 1 by calling the drive address (02H) with the “write” operation command (06H) to write the data (1770H) into the register (2001H).

Return Code (Drive to Host)

Address	OP Code	Drive Register		Register Data		CRC Checksum	
		MSB	LSB	MSB	LSB	LSB	MSB
02H	06H	20H	01H	17H	70H	DDH	EDH

The host writes data 1770H into the drive register 2001H. After receiving data from the host and writing data into drive’s registers, the drive returns the original receiving message to the host. OP code-06H of the host can synchronously broadcast to all drives but has no return code to the host.

※08H (Drive detection): Only use when testing the communication

OP code – 08H is to detect if the drive is correctly receiving the data from the host. The main purpose of using this OP code is to ensure the host data to be correctly sent to the drive.

Example: Verify the data (0000H and AA55H) to be correctly received by the drive.

Message Code (Host to Drive)

Address	OP Code	Data 1		Data 2		CRC Checksum	
		MSB	LSB	MSB	LSB	LSB	MSB
02H	08H	00H	00H	AAH	55H	5EH	A7H

The host sends OP-code (08H) to verify the data 0000H and AA55H to be correctly received by the drive.

Return Code (Drive to Host)

Address	OP Code	Data 1		Data 2		CRC Checksum	
		MSB	LSB	MSB	LSB	LSB	MSB
02H	08H	00H	00H	AAH	55H	5EH	A7H

The drive returns the same message to the host to confirm the data well received from the host. Data 1 must be 0000H but Data 2 can be any values.

Note: The host cannot simultaneously broadcast 08H OP code to all drives when multiple drives connected or drives reject drive's OP codes.

※10H (Write to multi-registers)

When multiple data need to write into the drive from the host, the host can define how many registers and data to be written into the drive.

This example is illustrating 2 data (1011H and 1770H) from the host to be written into 2 drive registers (2000H and 2001H).

Message Code (Host to Drive)

Address	OP Code	Starting Register		Register Number to Write		Data Length	Data 1		Data 2		CRC Checksum	
		MSB	LSB	MSB	LSB		MSB	LSB	MSB	LSB	LSB	MSB
02H	10H	20H	00H	00H	02H	04H	10H	11H	17H	70H	3FH	FBH

The host calls the drive 1 by defining the drive address (02H) with the write to multi-registers OP code (10H) to write 2 data (1011H and 1770H) into the drive registers (2000H and 2001H) which are defined by calling starting register (2000H) with "register number to write" (0002H). In this example, if user has 4 data to write to 4 drive registers, the message code can be as follows:

- Starting register: 2000H (still)
- Register number to write: 0004H

Then, 4 data will be sequentially written into 4 registers starting from 2000H, 2001H, 2002H, to 2003H.

Return Code (Drive to Host)

Address	OP Code	Starting Register		Register Numbers to Write		CRC Checksum	
		MSB	LSB	MSB	LSB	LSB	MSB
02H	10H	20H	00H	00H	02H	4AH	3BH

The host writes 2 data (1011H and 1770H) with total data length 4 byte to 2000H and 2001H registers of drive. The drive receives and writes the data to the registers, and then returns the message to the host. The host can synchronously broadcast all drives to write multi-data to multi-registers in order to change the data synchronously.

6-5 CRC Checksum Algorithm

CRC checksum code is to verify the message validity during the communication and its algorithm is to apply each code in the message to perform XOR and bit shifting operations to generate the CRC code.

Here is the checksum algorithm diagram to generate CRC code.



The following example of showing how CRC code is generated.

Example: To generate CRC code D140 from Address Code: 02H and OP Code: 03H

```

      1 1 1 1 1 1 1 1 1 1 1 1 1 1 1 1
First Code 02H 0 0 0 0 0 0 1 0 XOR
-----
MOVE 1 1 1 1 1 1 1 1 1 1 1 1 1 1 0 1
      0 1 1 1 1 1 1 1 1 1 1 1 1 1 0 1
      1 0 1 0 0 0 0 0 0 0 0 0 0 0 0 0 1
-----
MOVE 2 1 1 0 1 1 1 1 1 1 1 1 1 1 1 1 1
      0 1 1 0 1 1 1 1 1 1 1 1 1 1 1 1 1
      1 0 1 0 0 0 0 0 0 0 0 0 0 0 0 0 1
-----
MOVE 3 1 1 0 0 1 1 1 1 1 1 1 1 1 1 1 0
MOVE 4 0 1 1 0 0 1 1 1 1 1 1 1 1 1 1 1
      0 0 1 1 0 0 1 1 1 1 1 1 1 1 1 1 1
      1 0 1 0 0 0 0 0 0 0 0 0 0 0 0 0 1
-----
MOVE 5 1 0 0 1 0 0 0 1 1 1 1 1 1 1 1 0
MOVE 6 0 1 0 0 1 0 0 1 0 0 1 1 1 1 1 1 1
      0 0 1 0 0 1 0 0 1 1 1 1 1 1 1 1 1
      1 0 1 0 0 0 0 0 0 0 0 0 0 0 0 0 1
-----
MOVE 7 1 0 0 0 0 1 0 0 0 1 1 1 1 1 1 1 0
MOVE 8 0 1 0 0 0 1 0 0 1 0 0 1 1 1 1 1 1
      0 0 1 0 0 0 0 1 0 0 1 1 1 1 1 1 1
      1 0 1 0 0 0 0 0 0 0 0 0 0 0 0 0 1
-----
Second Code 03H 1 0 0 0 0 0 0 1 0 0 0 1 1 1 1 0
      0 0 0 0 0 0 1 0 0 1 1 1 1 1 0 1
-----
MOVE 1 1 0 0 0 0 0 0 1 0 0 1 1 1 1 0 1
      0 1 0 0 0 0 0 0 0 1 0 0 1 1 1 1 0 1
      1 0 1 0 0 0 0 0 0 0 0 0 0 0 0 0 1
-----
MOVE 2 1 1 1 0 0 0 0 0 1 0 0 1 1 1 1 1 1
MOVE 3 0 1 1 1 0 0 0 0 0 1 0 0 1 1 1 1 1
      1 0 1 0 0 0 0 0 0 0 0 0 0 0 0 0 1
-----
MOVE 4 1 1 0 1 0 0 0 0 0 1 0 0 1 1 1 1 0
MOVE 5 0 1 1 0 1 0 0 0 0 0 1 0 0 1 1 1 1
      0 0 1 1 0 1 0 0 0 0 0 1 0 0 1 1 1
      1 0 1 0 0 0 0 0 0 0 0 0 0 0 0 0 1
-----
MOVE 6 1 0 0 1 0 1 0 0 0 0 0 0 1 0 0 1 0
MOVE 7 0 1 0 0 1 0 1 0 0 0 0 0 0 1 0 0 1
      0 0 1 0 0 1 0 1 0 0 0 0 0 1 0 0 1
      1 0 1 0 0 0 0 0 0 0 0 0 0 0 0 0 1
-----
MOVE 8 1 0 0 0 0 1 0 1 0 0 0 0 0 1 0 1
MOVE 9 0 1 0 0 0 0 1 0 1 0 0 0 0 0 1 0 1
      1 0 1 0 0 0 0 0 0 0 0 0 0 0 0 0 1
-----
CRC : D 1 4 0

```

The following example of using C language to create a sample program for CRC checksum algorithm

Example: C language sample program

```

unsigned char *data; // Message pointer
unsigned char length; // Message length
unsigned int crc_chk(unsigned char *data,unsigned char length)
{
    int i;
    unsigned int reg_crc=0xffff;
    while(length--)
    {
        reg_crc^=*data++;
        for(i=0;i<8;i++)
            if(reg_crc&0x01)
                reg_crc=(reg_crc>>1)^0xa001;
            else
                reg_crc=reg_crc>>1;
    }
}

```

6-6 Processing Time of Communication Transmission

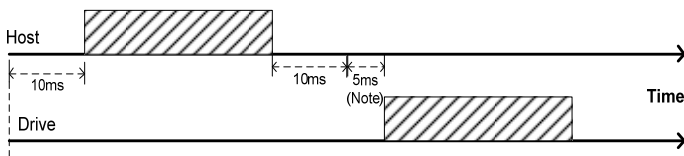

Communication Starts/Resets

The communication waits for 10ms to start the communication transmission after the drive powers on or the communication function of the drive changes. The drive needs 5ms processing time to return the message to the host after the message are received from the host. If the host only broadcasts to the drive, the host can start sending the message code after 5ms.

Note: if the message code is to “Read” or “Write” the parameter, the drive needs 100ms processing time to return the message to the host.

6-7 Communication Troubleshooting

1. When error occurs at the communication network, the drive provides the self-testing function to identify where error occurs. Please check communication function settings to verify the validity of functions.
2. When the host receives returned error messages from a drive, the host sends the invalid operation command to drive. The following table is the error message format.

Address	OP Code	Error Code	CRC Checksum	
			LSB	MSB
02H	1xxxxxxxB	xxH	xxH	xxH

OP code sets MSB (bit7) as 1 for the original command message, but error code gives different values according to different types of errors. The below table is describing types of error code:

Error Code	Error Type	Descriptions
0 0	Serial communication format error	Parity error of serial communication
0 1		Data frame error of serial communication
0 2		Over-bit error of serial communication
0 3	Modbus OP code error	OP code is not in either 03H,06H,08H, or 10H
0 4	Modbus CRC error	CRC checksum error
0 5	Modbus data range error	1. Data length in transmission not matched with the protocol 2. Data range over the register length at “write”
0 6	Modbus register characteristics error	Registers writes into read-only registers
0 7	Modbus register error	No-defined registers

6-8 Drive Registers and Command Code

●Registers – Write Operation

Reg. No.	Name	Description
AGnnH (see Note4)	Function setting	Drive function setting/monitoring; G: function group; nn: function number Example: F1.20=A114H
2000H	Operation command 1	b0~b1
		00: No use
		01: Stop
		10: Start
		11: JOG command
		b2~b3
		Reserved
		b4~b5
		00: No use
		01: Forward command
		10: Reverse command
		11: Rotation direction change command
		b6~b7
		00: Primary accel/decel time
		01: Second accel/decel time
		10: Third accel/decel time
11: Fourth accel/decel time		
b8~bA	000: Primary speed (communication)	
	001: Preset speed 1	
	010: Preset speed 2	
	011: Preset speed 3	
	100: Preset speed 4	
	101: Preset speed 5	
	110: Preset speed 6	
	111: Preset speed 7	
bB		
Reserved		
bC~bD	00: No use	
	01: b6~bA functions *Note 1	
	10: Enable operation command 2 resister.	
11: Disable 01 and 10		
bE~bF		
Reserved		
2001H	Frequency command	Primary frequency is set by communication (unit: 0.01Hz)
2002H	Operation command 2	b0
		1: External fault command
		b1
		1: Reset command
		b2
		1: Jog command
		b3
		1: Output interruption command
		b4
		1: Coast to stop command
b5		
1: Secondary accel/decel command		
b6		
1: Accel/decel prohibition command		
b7		
1: Select analog input source		
b8		
1: DC braking enable		
b9		
1: Secondary frequency selection		
bA~bF		
Reserved		

●Registers – Read Operation

Reg. No.	Name	Description	
2100H	Drive error code	00H	No error
		01H	Drive over current (OC)
		02H	Over voltage (OE)
		03H	Drive overheating (OH)
		04H	Drive overload (OL1)(OL2)
		05H	Motor overload (OL)
		06H	External fault (EF)
		07H	Short protection (SC)
		08H	A/D converter error (AdEr)
		09H	Reserved
		0AH	Reserved
		0BH	Reserved
		0CH	Reserved
		0DH	Grounding fault (GF)
		0EH	Under voltage during operation (LE1)
		0FH	EEPROM error (EEr)
2101H	Drive status 1	b0~b7	Reserved
		b8	1: Frequency control by communication
		b9	1: Frequency control by analog inputs
		bA	1: Operation command by communication
		bB	1: Parameter locking
		bC	1: Drive running status
		bD	1: Jog running status
		bE	1: Forward indication
bF	1: Reverse indication		
2102H	Frequency command	Monitor drive's frequency command (unit: 0.01Hz)	
2103H	Output frequency	Monitor drive's output frequency(unit: 0.01Hz)	
2104H	Output current	Monitor drive's output current(unit: 0.1A)	
2105H	DC bus voltage	Monitor drive's DC bus voltage(unit: 0.1V)	
2106H	Output voltage	Monitor drive's AC output voltage(unit: 0.1V)	
2107H	Frequency of multi-speed	Monitor drive's frequency of multi-speed *Note 2	
2108H	Reserved		
2109H	Reserved		
210AH	Reserved		
210BH	Reserved		
210CH	Reserved		
210DH	Reserved		

210EH	Reserved		
210FH	Reserved		
2300H	I/O terminal status	b0	Reserved
		b1	Reserved
		b2	1: X1 terminal operation
		b3	1: X2 terminal operation
		b4	1: X3 terminal operation
		b5	1: X4 terminal operation
		b6	Reserved
		b7	Reserved
		b8	1: Y1 terminal detection
		b9	Reserved
		bA	Reserved
		bB	Reserved
		bC	1: Primary speed by analog input
		bD	1: Primary speed by operation panel
		bE	1: Primary speed by UP/DOWN command
bF	1: Primary speed by communication		
2301H	Drive status 2	b0	Reserved
		b1	1: Constant speed
		b2	1: Zero speed
		b3	1: Frequency detection
		b4	1: System overload
		b5	1: Stall prevention
		b6	Reserved
		b7	1: Braking action
		b8	Reserved
		b9	Reserved
		bA	1: Error signal
bB~bF	Reserved		
2302H	Reserved		
2303H	Fault record 1	Fault record 1 *Note 3	
2304H	Fault record 2	Fault record 2 *Note 3	
2305H	Fault record 3	Fault record 3 *Note 3	
2306H	Fault record 4	Fault record 4 *Note 3	
2307H	Fault record 5	Fault record 5 *Note 3	

Note:

1. When the function is enabled, multi-function command –Multi-speed 1, 2, 3, will be inactive.

2. 0: Analog

1: Primary speed

2~16: Multi-speed 2~16

















17: Jog speed

18: UP/DOWN command

19: Frequency command of sequential operation control

21: Communication

3. Fault record table

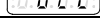
Error code	Drive display	Description
01H	 (AdEr)	A/D converter error
02H	 (Fot)	IGBT module error
03H	 (EEr1)	Internal memory error
08H	 (OC)	Drive over current
0CH	 (OE)	Over voltage
0DH	 (LE1)	Under voltage during operation
0EH	 (GF)	Grounding fault
0FH	 (OH)	Drive overheat
10H	 (OL)	Motor overload
11H	 (OL1)	Drive overload
12H	 (OLO)	System overload
13H	 (EF)	External fault
14H	 (PAdF)	Keypad interruption during copy
16H	 (ntcF)	Thermal sensor fault
17H	 (OH2)	Motor overheat
18H	 (noFb)	PID feedback signal error
19H	 (OL2)	Drive current limit

4. AGnnH—Write and read allowed

2000H–2002H—Write only, read prohibited

2100H–210FH—Read only, write prohibited

6-9 Programming Examples – Register and Command

6-9-1 Access Drive Function Setting – Write Operation

Write a single register to access drive function setting:

- Set function F2.00 (primary speed) = 30 Hz
- Speed setting is directly input by function setting
- Drive register used: AGnnH → F2.00: G = 2; nn = 00 (decimal value) = 00H(Hex). F2.00 = A200H register
- Speed = 30Hz → 30.00Hz(resolution: 0.01Hz) → 30.00 x 100 = 3000 (decimal) = 0BB8H (hex)
- The host controls only one drive(drive 1)

Code to write to drive register from the host (CRC exclusive)

Address	OP Code	Drive Register		Register Data	
		MSB	LSB	MSB	LSB
01H	06H	A2H	00H	0BH	B8H

6-9-2 Host Control to Drive – Write Operation

When the host control by Modbus communication, user can simply create an icon or active key/button to activate the drive. The following examples shows how to program the communication control.

1. Start the drive:

- Create an icon or active button/key on the host for “Drive Start”
- Program the host with the following code for “Drive Start”
- The drive register to be written for start operation: 2000H
- The register data for start operation: 0002H

Address	OP Code	Drive Register		Register Data	
		MSB	LSB	MSB	LSB
01H	06H	20H	00H	00H	02H

2. Forward rotation command:

- Create an icon or active button/key on the host for “Forward”
- Program the host with following code for “Forward” rotation control
- The drive register to be written for forward command: 2000H
- The register data for forward command: 0010H

Address	OP Code	Drive Register		Register Data	
		MSB	LSB	MSB	LSB
01H	06H	20H	00H	00H	10H

3. Speed Setting (frequency command) – without using drive function setting:

Set the speed to be 30.05Hz (resolution: 0.01Hz)

- The drive register to be written for Speed setting(frequency command): 2001H
- Convert 30.05Hz to hexadecimal value:
30.05 x 100 (by the resolution) = 3005 (decimal) = 0BBDH

Address	OP Code	Drive Register		Register Data	
		MSB	LSB	MSB	LSB

01H	06H	20H	01H	0BH	BDH
-----	-----	-----	-----	-----	-----

4.Primary Acceleration/Deceleration Time Setting:

Set the acceleration/deceleration time = 1.5 seconds (resolution: 0.1 seconds)

- a. Set F2.18 (Primary accel time) = 1.5 seconds

Convert F2.18 to hexadecimal value for generating register number:
18 (decimal) = 12H

Convert 1.5 seconds to hex value: 1.5×10 (by resolution) = 15
(decimal) = 000FH

- b. Set F2.19 (Primary decel time) = 1.5 seconds

Convert F2.19 to hex value: 19 (decimal) = 13H

- c. Select primary accel/decel time command: register: 2000H, register data = 00 (b6,b7)

Set the acceleration time F2.18 = 1.5 seconds

Address	OP Code	Drive Register		Register Data	
		MSB	LSB	MSB	LSB
01H	06H	A2H	12H	00H	0FH

Set the deceleration time F 020 = 1.5 seconds

Address	OP Code	Drive Register		Register Data	
		MSB	LSB	MSB	LSB
01H	06H	A2H	13H	00H	0FH

Select primary acceleration/deceleration time

Address	OP Code	Drive Register		Register Data	
		MSB	LSB	MSB	LSB
01H	06H	20H	00H	00H	00H

6-9-3 Host Control to Drive – Read Operation

1. Drive Error Trips (Fault Code):

Example: Drive error trips due to “GF” (grounding fault) and the fault message displayed at the host.

- a. The host sends the below codes to access the drive register to monitor drive faults (read only one register data)

-Drive register: 2100H

-Number of register to read: 1 → 0001H

Message Code (Host to Drive)

Address	OP Code	Drive Register		Register Numbers to Readout	
		MSB	LSB	MSB	LSB
01H	03H	21H	00H	00H	01H

- b. The drive returns the fault code to the host when “GF” occurs:
-GF code: 0DH

Return Code (Drive to Host)

Address	OP Code	Data Byte	2100H(Register) Data	
			MSB	LSB
01H	03H	04H	00H	0DH

- c. Program the host to convert register data 000DH to “GF”

2. Drive Frequency Output Readout:

Example: If the drive frequency outputs = 40.65Hz, read the data output from the drive and display 40.05Hz in the host.

- a. The host sends the below codes to access the drive register to read out the frequency output data (read only one register data)

-Drive register: 2103H

-Number of register to read: 1 → 0001H

Message Code (Host to Drive)

Address	OP Code	Drive Register		Register Numbers to Readout	
		MSB	LSB	MSB	LSB
01H	03H	21H	03H	00H	01H

- b. The drive returns the frequency output readouts to the host
-Output frequency readouts from the drive (2103H register data):

Return Code (Drive to Host)

Address	OP Code	Data Byte	2103H(Register) Data	
			MSB	LSB
01H	03H	04H	0FH	E1H

- c. Program the host to convert register data 0FE1H (Hex value) = 4065 (Decimal value)
- d. Display the output frequency (resolution = 0.01): $4065/100 = 40.65$ (unit in Hz)

Chapter 7 Operation Procedures and Fault Protection

7-1 Operation Procedures



DANGER

1. Do Not remove wires when the internal indicator of the drive remains ON.



CAUTION

1. Check if the shield of wire is broken after wiring is completed to avoid electric leakage or short circuit.
2. Screws on the terminal must be fastened.

- A. Verify and check the compatibility between power source, voltage, motor, and drive.
- B. Connect the power to drive R/L1, S/L2, T/L3 (three-phases) or R/L1, S/L2 terminals(single-phase).
- C. Set all required parameters and functions after power is ON and measure the output voltage of the drive at U/T1, V/T2, W/T3 terminals to verify if the output voltage and current are valid. Press  when completing all verifications.
- D. Switch off the power and wait for drive's power indicators off, and then connect drive's U/T1, V/T2, W/T3 terminals to the motor.
- E. Operate the motor with the drive by low speed after power on to verify the validity of the motor rotation direction and then to slowly increase the motor speed.
- F. Motor start or stop must be controlled by drive control signal instead of switching the power on/off. The lifetime of the drive will be significantly reduced if the invalid operation using the switch control of the power is applied to motor control.
- G. Because the starting current of motor is 6~8 times of rated current, Do NOT install the magnetic contactor between the drive and motor for the motor operation.
- H. When using the single-phase power source to drive the three-phase drive (not the standard type of single-phase power input), first confirm the horsepower of motor, and then calculate the motor rated current by multiplying the motor rated current by 2 to gain the drive rated current. The drive selection for this single-phase power must have the rated current equal to the calculated drive rated value.

Formula: Motor rated current $\times 2$ = drive rated output current

Example:

a. Drive selection:

Motor specification: 220VAC, 1HP ; rated current: 3.1A

Drive rated current=3.1 (A) $\times 2$ = 6.2 (A)

Drive specifications: 230VAC, 1HP drive = 4.2A(continuous current)
2HP drive = 8A(continuous current)

⇒ Select 2HP drive for 1HP AC motor.

b. Connect the wires of single-phase power with R/L1,S/L2 terminals.

c. Parameter setting:

Please reset above parameters. If the parameters are not modified, the motor and drive could be possibly damaged.

F4.08 (Motor Rated Current)=3.1A

(the setting must be based on the motor rated current)

F4.28 (Overload Detection Level)=80

(the half of the default setting value 160%)

F3.04 (Stall Prevention Level at the Constant Speed)=80

(the half of the default setting value 160%)

7-2 Fault Protection Display and Troubleshooting





A: Description:

The drive has well protection functions to protect drive and motor when faults occur. When the fault occurs, the drive trips by the protection functions and display the fault message on operation panel. After the fault is



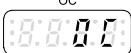

troubleshooted, reset the drive by pressing “STOP RESET” of the drive operation panel or by the external operation reset signal to the drive multi-function input terminals.

B: Protection and Troubleshooting List:

Drive error trip message

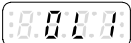
Display	Description	Cause	Troubleshooting
<p>Fot</p> 	<p>IGBT module error</p>	<ul style="list-style-type: none"> •Error on the drive power system. •Drive outputs fault current. •High temperature on IGBT module. 	<p>Return the drive to repair when reset command from multi-function input terminal or “STOP RESET” are useless.</p>
<p>GF</p> 	<p>Grounding fault</p> <ul style="list-style-type: none"> •The three-phase output current is unbalance and exceeding the detection level of grounding fault. •Grounding fault detection level: F4.01. 	<p>The output terminal of the drive is short or grounding.</p>	<ul style="list-style-type: none"> •Check the insulation value of motor. •Check the shield of motor's wire.
<p>OC</p> 	<p>Drive over current</p> <ul style="list-style-type: none"> •The drive current during the operation exceeds 220% of drive's rated current. 	<ul style="list-style-type: none"> •The output terminals of drive are short. •The load is too heavy. •The acceleration time is too short. •Drive is immediately restarted during coast to stop. •Use special motor. 	<ul style="list-style-type: none"> •Check wires of U/T1,V/T2,W/T3 terminals to verify if there is short between terminals. •Check the motor and drive compatibility. •Check the motor operated in over-rated running.
<p>OL</p> 	<p>Motor overload</p> <ul style="list-style-type: none"> •Operation current exceeds 150% of motor's rated current and reaches the motor overload protection time. •Active time: F4.10. 	<ul style="list-style-type: none"> •Motor is overloaded. •The voltage setting of V/F pattern is too high or too low. •The current setting of motor's rated current is invalid. 	<ul style="list-style-type: none"> •Check the load of motor. •Check if the acceleration or deceleration time is too short. •Check if V/F setting is proper. •Check if the rated current setting is valid.

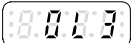

Drive error trip message

Display	Description	Cause	Troubleshooting
<p>OL1</p> 	<p>Drive overload</p> <ul style="list-style-type: none"> • Operation current exceeds 150% of drive's rated current and continues for 1minute. 	<ul style="list-style-type: none"> • Motor overload. • The voltage setting of V/F pattern is too high or too low. • Drive capacity is too small. 	<ul style="list-style-type: none"> • Check the load of motor if overload. • Check if the acceleration or deceleration time is too short. • Check if V/F setting is proper. • Select the higher capacity of drive.
<p>OL2</p> 	<p>Drive current limit</p> <ul style="list-style-type: none"> • Operation current exceeds 200% of drive's rated current. 	<ul style="list-style-type: none"> • Motor overload. • Acceleration time is too short. • Immediate restart after coast to stop. 	<ul style="list-style-type: none"> • Check the motor and drive compatibility. • Check if the motor is operated in over-rating condition.
<p>OL3</p> 	<p>Braking transistor overload</p>	<p>The frequent braking action causes the temperature of the braking transistor too high.</p>	<p>Increase the deceleration time.</p>
<p>OLO</p> 	<p>System overload</p> <ul style="list-style-type: none"> • Load is too heavy and the operation current reaches the active level. • Detection level: F4.28 • Detection time: F4.29 	<p>---</p>	<p>Check the usage of mechanical equipment.</p>
<p>OE</p> 	<p>Over voltage</p> <ul style="list-style-type: none"> • The internal DC bus voltage is over the protection level. • 100V/200V series: About DC410V • 400V series: About DC820V 	<p>The deceleration time of motor is too short causing the regeneration voltage too high on DC bus.</p>	<ul style="list-style-type: none"> • Increase the setting value of deceleration time • Use high torque braking method. • Add dynamic brake unit to reduce regenerate voltage.
		<p>Power source is too high.</p>	<p>Check if the input power is within drive's rated range.</p>

Drive error trip message

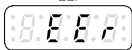

Display	Description	Cause	Troubleshooting
<p>LE1</p>	<p>Under voltage during operation The internal DC bus voltage is below 70% of power source for 200V/400V series drive or 50% of power source for 100V series drive.</p>	<ul style="list-style-type: none"> Phase failure of input power. Instantaneous power off. Voltage variation of power source is too high. Motor with instant overload causes the high voltage drop. 	<p>Increase the power capacity by selecting higher capacity drive to avoid the voltage drop of the power cord.</p>
<p>ntcF</p>	<p>Thermal sensor fault</p>	<p>Drive thermal sensor (NTC) is fault.</p>	<p>Please call customer service for drive repair.</p>
<p>OH</p>	<p>Drive overheat</p> <ul style="list-style-type: none"> The temperature of drive's heat sink reaches the trip level. Trip level: F4.12 	<ul style="list-style-type: none"> The surrounding temperature is too high. The heat sink has foreign body. The cooling fan of drive is fault. 	<ul style="list-style-type: none"> Improve the ventilation. Clean the dust on the heat sink. Return the drive to replace the cooling fan.
<p>OH2</p>	<p>Motor overheat</p> <ul style="list-style-type: none"> The internal temperature of motor is over the trip level. Trip level: F4.23 	<p>Motor is overheat.</p>	<ul style="list-style-type: none"> Check if the motor load is too heavy. Check if the accel./decel. time is too short. Check if V/F setting is proper.
<p>noFb</p>	<p>PID feedback signal error</p>	<p>The feedback signal wire tripped.</p>	<p>Check the feedback signal wire.</p>
<p>AdEr</p>	<p>A/D converter error</p>	<p>---</p>	<p>Please call customer service for drive repair.</p>
<p>EF</p>	<p>External fault</p>	<p>The multi-function terminal receives the external fault signal.</p>	<p>Clear the external fault and then press key.</p>
<p>PAdF</p>	<p>Keypad interruption during copy</p>	<ul style="list-style-type: none"> The connecting wire of the keypad is loosen. The keypad jack of the drive is oxidized. 	<p>Check the connecting wire of keypad.</p>

Drive error trip message

Display	Description	Cause	Troubleshooting
<p>EEr</p> 	EEPROM error	<ul style="list-style-type: none"> •EEPROM data write fault. •EEPROM component defected. 	<ul style="list-style-type: none"> •Please reset all parameters to default value and restart the drive. •Return the drive to repair, when the fault cannot be eliminated.
<p>EEr1</p> 	Internal memory error	CPU RAM is malfunction.	Please call customer service for drive repair.
<p>EEr2</p> 	Internal memory error	The software checksum is incorrect.	Please call customer service for drive repair.

Drive warning message

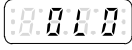

*Drive will stop output when displaying below messages. After the fault conditions are troubleshooted, the drive will recover to normal condition.

Display	Description	Cause	Troubleshooting
<p>OLO</p> 	System overload <ul style="list-style-type: none"> •Load is too heavy and the operation current reaches the active level. •Detection level: F4.28 •Detection time: F4.29 	---	Check the usage of mechanical equipment.
<p>Hv</p> 	Power source over voltage The internal DC bus voltage of drive is over the protection level during stop.	Power source voltage is too high.	Check if the input power is within drive's rated range.
<p>db</p> 	Braking transistor is active <ul style="list-style-type: none"> •The internal DC bus voltage of drive is over the protection level. •Setting level:F3.27 	The deceleration time of motor is too short causing the regenerate voltage too high on DC bus.	<ul style="list-style-type: none"> •Increase the setting value of "deceleration time". •Use high torque braking method. •Add dynamic brake unit to reduce regenerate voltage

<p>LE</p>	<p>Power source under voltage</p>	<p>The voltage of power source is too low.</p>	<p>Check if the voltage of power source is normal.</p>
<p>OHT</p>	<p>Drive overheat</p> <ul style="list-style-type: none"> •The temperature of drive's heat sink reaches the protection level. •Setting level: F4.12 	<ul style="list-style-type: none"> •The surrounding temperature is too high. •The heat sink has foreign body. •The cooling fan of drive is fault. 	<ul style="list-style-type: none"> •Improve the ventilation. •Clean the dust on the heat sink. •Return the drive to replace the cooling fan.
<p>OHT1</p>	<p>Motor overheat</p> <ul style="list-style-type: none"> •The internal temperature of motor is over the warning level. •Warning level: F4.21 	<p>Motor is over heat.</p>	<ul style="list-style-type: none"> •Check if the motor load is too heavy. •Check if the accel./decel. time is too short. •Check if V/F setting is proper.

Drive warning message

Display	Description	Cause	Troubleshooting
<p>bb</p>	<p>Drive output interruption</p>	<p>Drive stops the output when the output interruption command is activated.</p>	<p>Clear drive output interruption command.</p>
<p>Fr</p>	<p>Coast to stop</p>	<p>Drive stops the output when the coast to stop command is activated.</p>	<p>Clear "coast to stop" command.</p>
<p>dtF</p>	<p>Forward/reverse command input simultaneously</p>	<p>Input the forward/reverse command to one of X1~X4 terminals simultaneously.</p>	<p>Check the control command.</p>
<p>Inter-display with frequency command</p>	<p>No input of forward/reverse command</p>	<p>---</p>	<p>Check rotation direction command.</p>
<p>WvF</p>	<p>Different software version inter-copy</p>	<p>The software version of drives is different.</p>	<p>Check up the software version is corresponded.</p>
<p>Cot</p>	<p>Modbus communication overtime</p>	<ul style="list-style-type: none"> •Communication wire is loosen or connecting wire is incorrect. 	<ul style="list-style-type: none"> •Check the wiring of communication wire.

		<ul style="list-style-type: none"> •Communication setting of host and receiver are different. 	<ul style="list-style-type: none"> •Check the communication setting.
<p>Err00</p>  <p>Err01</p> 	<p>Err 00: Keypad cable trip before connecting.</p> <p>Err 01: Keypad cable trip during operation.</p>	<ul style="list-style-type: none"> •The connecting wire of the keypad is loosen. •The keypad jack of the drive is oxidized. 	<p>Check the wire between the keypad and drive.</p>

Appndix A Outline Dimension Drawings

Appendix A Outline Dimension Drawings

Overall Dimensions of Drive

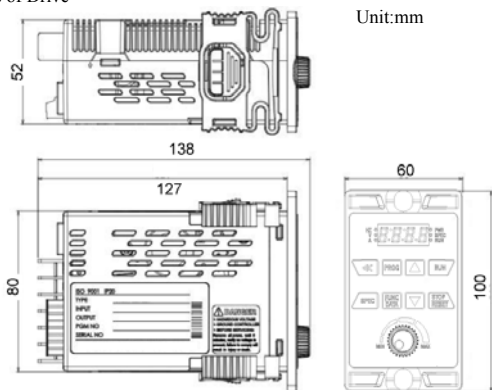

1. Removable bracket frame

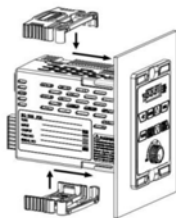
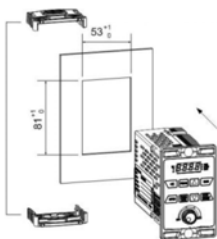

2. Fixing screws

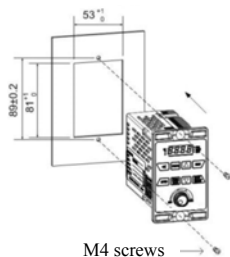

交流馬達變頻器

AC MOTOR DRIVE

操作手冊

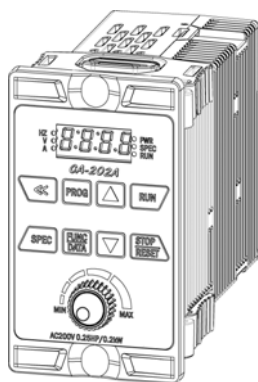

CA 系列

CA Series



序 言

感謝您採用 TPG CA 系列變頻器，在安裝前請詳細閱讀本說明書，為了能正確的操作與安全使用。

安全注意事項

安裝、配線、運轉保養或故障排除之前，請詳細閱讀本說明書並注意內容之安全注意事項及「**危險**」、「**注意**」二項標示符號或文字。

※專業合格人員：熟悉變頻器之原理、構造、特性、操作程序、安裝，能遵守安全措施預防危險發生，並詳閱說明書之人員。

 危險	表示若不按說明書上之指示去執行工作，可能引起人員傷亡或嚴重的傷害。
 注意	表示若不按說明書上之指示去執行工作，可能造成人員的傷害或產品設備的損壞。

※雖然“”表示較輕微損傷等級，如果沒有依照注意事項執行工作，也有可能引起嚴重的損壞或傷害。

安裝

 注意
<ol style="list-style-type: none">1. 需安裝在金屬物體或防火材料上，並避開高溫、潮濕、油氣、棉絮、金屬粉或腐蝕性氣體之場所。2. 產品規格如標示為IP00結構保護等級時，安裝後需避免人員碰觸，以免發生觸電危險；另有選配加裝交流電抗器(ACL)也需注意。3. 變頻器安裝於控制盤內時，需注意盤內溫度不能高於50°C。4. 變頻器儲存與安裝環境，請遵守共同規格章節中所規定之環境條件。

簡介

特點

1. 多功能特殊鍵(SPEC)：
可自行規劃正反轉、寸動、主/副頻...等多機能控制。
2. 支援RS-485通訊控制介面 (Modbus RTU通訊協定)。
3. 共6組異常履歷，可分別記錄異常時4種狀態(異常碼、異常時輸出電流、異常時DC bus電壓、異常時輸出頻率)。
4. 可顯示變頻器送電時數與運轉時數。
5. 設定項次群組化分類，方便功能設定及參數管理。
6. 具程序運轉控制及PID控制功能。
7. 可顯示8種監看畫面 (其中3個另有12種監看畫面可選擇)。
8. 具PTC馬達過熱保護功能。
9. 輕載時可設定省能源模式。
10. 具自動轉矩提升功能。
11. 具8段速度控制。
12. 類比輸入濾波可調整。
13. 可調整數位輸入信號之反應時間(遲滯偵測可調)。
14. 類比輸入信號可選擇V、F獨立調整。
15. 二組類比輸入信號可做加、減、增益的控制。
16. 載波頻率設定範圍800Hz~16kHz。

1 安裝前注意事項

1-1 產品確認

本產品出廠前皆已通過嚴格的品管測試，但考慮產品在運輸過程中可能會因衝撞、搖晃、震動…等因素，造成產品些微損壞，所以當您收到購買的產品後，請確認並查驗以下各項，如有查驗後發現任何異常，請立即通知代理商進一步處理。

1-1-1 外觀、銘牌確認

1. 檢查外包裝箱機種型號是否與變頻器機種型號是否相同。
2. 檢視變頻器外觀是否有烤漆脫落、汙損、變形等情形。
3. 查看變頻器上的銘牌內容，是否與您所訂購的產品規格相符。

ISO 9001 IP20

TYPE	CA-202A	XXXX	→ 型號名稱
INPUT	1PH AC200-240V 3A 50/60Hz	XXXX	→ 輸入電源規格
OUTPUT	3PH AC200-240V1.5A 0.1-400Hz	XXXX	→ 輸出電流與容量規格
PGM NO.	0201-1	XXXX	→ 軟體編號與產品編號
SERIAL NO.	XXXXXXXX	XX	→ 生產序號

1-2 標準規格

型號	CA-201A	CA-202A
最大適用馬達(W)	125	200
額定輸出容量(VA)	400	600
額定輸出電流(A)	0.9	1.5
額定輸出電壓(V)	三相 200~240V	
輸出頻率範圍(Hz)	0.1~400Hz	
電源(Ø,V,Hz)	單相, 200~240V, 50 / 60Hz	
輸入電流(A)	1.7	3
容許電壓/頻率變動率	176V~264V 50/60Hz ±5%	
過負載保護	額定輸出電流 150%1 分鐘	
冷卻方式	自然冷卻	
通過認證式樣	-	
保護結構	IP20	
重量	384g	

如登錄資料與您訂貨資料不符或有任何問題，請與接洽之代理商聯絡

1 安裝前注意事項

1-2 共同規格

1-2-1 控制特性及運轉特性

控制特性	控制方式	正弦 PWM 方式(V/F 控制)，載波頻率：800~15kHz
	頻率控制範圍	0.1~400.0Hz
	頻率設定解析度	操作面板：0.01Hz(0.01~99.99Hz/100.0~400.0Hz) 類比信號：0.06Hz/60Hz
	輸出頻率解析度	0.01Hz
	過負載容量	變頻器額定輸出電流的 150%、跳脫時間 1 分鐘
	直流制動	啟動/停止制動時間 0~60.0 秒 停止制動頻率 0.1~60Hz 制動能力 0~150%的額定電流
	制動轉矩	約 20%
	V/F 曲線	V/F 曲線(2 個轉折點) 1.5、1.7、2 次方遞減曲線 V/F 曲線的 V 獨立調整(獨立的 V 加減速調整)
運轉特性	其他機能	滑差補償、自動轉矩補償、自動穩壓輸出調節、自動節能運轉、自動載波調整、瞬間停電再啟動、速度追蹤、過轉矩檢出、直流制動、計數器功能、Modbus(RS-485)通訊、跳躍頻率、緩行頻率、輸出頻率上下限、8 段速度、加減速切換、S 曲線加減速、溫度管理、參數複製
	頻率設定信號	操作面板(含操作器)：▲、▼ 類比信號：(DC 0-5V)/0~100% 數位信號：寸動運轉、8 段速度選擇 Modbus(RS-485)通訊
	運轉設定信號	操作面板(含操作器)：RUN、STOP 數位信號：正/反運轉控制、Modbus(RS-485)通訊
	多機能輸入	3 組可規劃輸入點：X1-X3 反應時間(1~255，單位 1ms)
		功能請參考項次 F5.19~F5.21
類比輸入	1 組類比輸入：VI (0-10V) 類比濾波(0~255，單位 5ms)、類比頻率不感帶、增益偏壓可調整	

2 安裝與確認

2-1 基本配備

變頻器之運作，需由一些元件組合而成才能產生效用，這些元件稱為基本配備。其包含如下：

2-1-1 電源：依照變頻器規格選定三相或是單相電源。

2-1-2 無熔絲開關：當電源開啟時，無熔絲開關可忍受突波電流，並且提供變頻器過負載和過電流保護。

2-1-3 變頻器：馬達的控制主體；不同馬達極數或不同額定電壓之馬達，額定電流值會有差異，因此選用變頻器時，應以馬達額定電壓及額定電流為依據，勿只以馬達之馬力數為參考條件(請參考變頻器標準規格)。

2-1-4 馬達：按照實際的需求決定馬達；請注意馬達的額定電流不可大於變頻器電流。

註：CA變頻器為三相感應馬達專用，無法控制單相馬達。

2-2 環境條件

為了讓變頻器能安全的運作，必須注意安裝環境的情況。

條件如下：

2-2-1 電源：依照變頻器規格選定三相或單相電源。(請參考CA標準規格)

2-2-2 位置：變頻器運轉時基於散熱考量，機器周圍必須有足夠的通風散熱距離，所以變頻器周圍最小距離，如下圖所示：

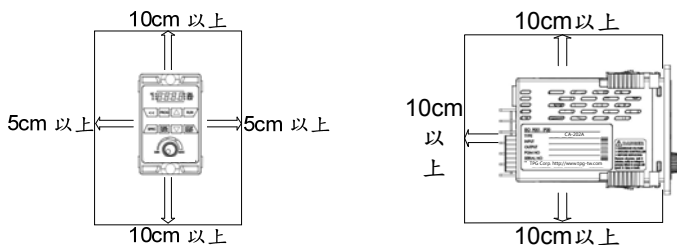

2 安裝與確認

2-2-3 相關配備規格： 相關配備的選用，必須配合所使用的變頻器規格，過與不及都可能造成變頻器的損毀或壽命降低。



請勿在變頻器和馬達之間加裝進相電容(RC、LC或其它電容元件)，避免任何工安意外。

2-2-4 環境整潔： 變頻器安裝的環境需考量通風、清潔、溫溼度。

2-2-5 操作人員： 需技術有認證過人員才可進行操作和問題排除。

2-3 接線圖和端子敘述

2-3-1 接線圖

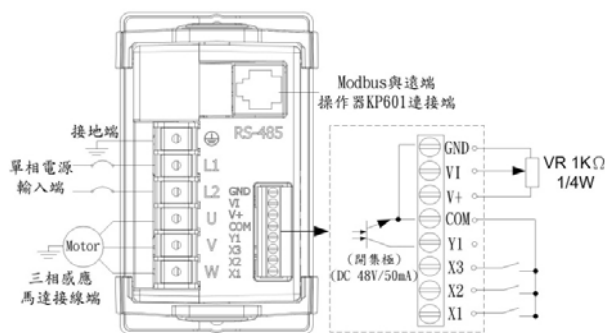

2-3-2 端子說明

1. 主迴路端子配置

端子種類	端子記號	端子名稱	說明
主迴路端子	電源	L1, L2	交流電源輸入端子 單相正弦波 AC200~240V 電源輸入。
	馬達	U, V, W	輸出至馬達端子 三相輸出接至三相感應馬達。
	接地	⊕	接地用端子 第三種接地 100Ω 以下

2. 控制迴路端子控制

端子種類	端子記號	端子名稱	說明	
控制迴路端子	多機能輸入端子	X1	輸入端子 1	指令輸入端子，與 COM 短路，端子動作，功能請參考 F5.19~F5.21 多機能輸入設定
		X2	輸入端子 2	
		X3	輸入端子 3	
	多機能輸出端子	Y1(TA/TC)	輸出端子 1	參數檢出後與 COM 導通 設定參考 F5.26
		COM	輸出/入共用端子	輸出/入控制信號共用點
	控制電源	V+	控制用電源端子	DC+12V 輸出，最大供應電流 20mA。
VI		類比輸入信號端子	DC 0~10V	
GND		控制用零電位端子	零電位端子	

2 安裝與確認

3. Modbus連接座(RJ-45)

端子種類	端子腳位	端子名稱	說明
Modbus (RS-485)  8←1	1	通訊傳輸端子(DX+)	Modbus(RS-485)通訊使用 1, 2 腳位
	2	通訊傳輸端子(DX-)	
	3-8	保留	保留

3-1 操作面板狀態與監看模式

3-1-1 操作面板的操作狀態

操作面板的操作狀態包含異常訊息與三種模式，切換方法如下圖所示：



操作步驟如下表(以出廠設定為例)：

操作步驟	顯示
1.開機進入主畫面。	Hz V A: 0.00 CRG RUN
2.按 PROG 鍵，進入設定項次選擇模式。	Hz V A: F.0.00 CRG RUN
3.按 FUNC DATA 鍵，進入參數設定模式。	Hz V A: 6.2.1.1 CRG RUN
4.按 FUNC DATA 鍵返回設定項次選擇模式。	Hz V A: F.0.00 CRG RUN
5.按 PROG 鍵返回監看模式。	Hz V A: 0.00 CRG RUN

異常信號顯示：

操作步驟	顯示
變頻器運轉中跳出異常信號。	Hz V A: 8.8.0H CRG RUN
1.異常排除後，按 STOP RESET 鍵清除異常並返回監看模式。	Hz V A: 0.00 CRG RUN

3 操作面板及遠端操作器設定

3-1-2 監看模式

在監看模式下共有八個監看畫面可切換，包含一個主畫面與七個輔助畫面，如下表所示：

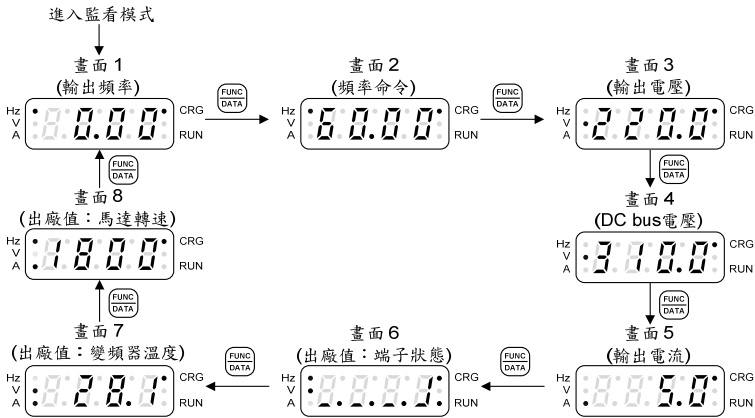

監看畫面說明如下表(以出廠設定為例)：

畫面	說明	顯示
畫面1	輸出頻率(Hz、CRG：亮)	Hz V A : 8 0.00 CRG RUN
畫面2	頻率命令(Hz、CRG：亮)	Hz V A : 6 0.00 CRG RUN
畫面3	輸出電壓(V、CRG：亮)	Hz V A : 2 20.0 CRG RUN
畫面4	DC bus電壓(V、CRG：亮)	Hz V A : 3 10.0 CRG RUN
畫面5	輸出電流(A、CRG：亮)	Hz V A : 8 8.5.0 CRG RUN
畫面6	端子狀態(Hz、V、CRG、RUN：亮)	Hz V A : 8.8.8.0 CRG RUN
畫面7	變頻器溫度(V、A、CRG：亮)	Hz V A : 8 28.0 CRG RUN
畫面8	馬達轉速(Hz、A、CRG：亮)	Hz V A : 1 80.0 CRG RUN

- 八個監看畫面的任何一個可設定為主畫面，其他為輔助畫面，在監看模式下按 鍵切換畫面1~畫面8；設定方式由設定項次F1.08選擇。
- 可選擇比較重要的輔助畫面作主畫面，系統會在操作於輔助畫面下閒置約3分鐘後，自動切換回主畫面。
- 畫面6~8由設定項次F1.09~F1.11決定。

3 操作面板及遠端操作器設定

3-1-3 多機能端子狀態

畫面6於出廠狀態為多機能端子狀態顯示，七段顯示器上各位置所代表的端子代號如下圖：

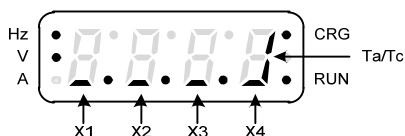

顯示畫面所代表意義如下表：

顯示畫面	端子	狀態說明
	X1	多機能輸入端子X1功能動作。
	X2	多機能輸入端子X2功能動作。
	X3	多機能輸入端子X3功能動作。
	Y1	多機能輸出Y1端子動作

3-3-4 設定項次選擇模式功能說明

a. 群組編號選擇：





操作步驟	顯示
1. 監看模式下按 鍵進入設定項次選擇模式；群組編號閃爍。	
2. 按 鍵增加設定群組編號。	
3. 按 鍵減少設定群組編號。 群組編號範圍請參閱「4. 設定項次一覽表」	

b. 群組編號／項次編號切換

操作步驟	顯示
1. 群組編號閃爍時，按 鍵切換到項次編號。	
2. 項次編號閃爍時，按 鍵切換到群組編號。	

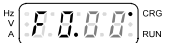
3 操作面板及遠端操作器設定











C. 項次編號選擇：

操作步驟	顯示
1. 選定群組編號後，按  鍵切換到項次編號；項次編號閃爍。	
2. 按  鍵，項次編號增加。	
3. 按  鍵，項次編號減少 項次編號範圍請參閱「4. 設定項次一覽表」。	

備註：淺色字代表閃爍

3-1-5 參數設定模式

設定範圍由該設定項次決定，操作步驟如下表：

操作步驟	顯示
1. 設定項次選擇模式；以F2.17 (輸出頻率)為例。	
2. 於設定項次選擇模式按  鍵，進入參數設定模式。	
3. 按  鍵，移動小數位數；以小數點後一位為例。	
4. 按  鍵輸出頻率加0.1。	
5. 按  鍵輸出頻率減0.1。	
6. 按  鍵回到設定項次選擇模式。	

- 資料被改變時，數值閃爍(淺色代表閃爍)。
- 設定項次 F2.17 的資料設定範圍為 0.00~400.00Hz。

3 操作面板及遠端操作器設定

3-1-6 監看模式下的操作

在監看模式下可更改頻率命令、馬達轉速(RPM)、線速度(MPM)。以更改頻率命令為範例，說明如下圖所示：

操作步驟如下表：

操作步驟	顯示
1. 監看模式；以頻率命令為例。	Hz V A 60.00 CRG RUN
2. 按 << 鍵，移動頻率命令位數。	Hz V A 60.00 CRG RUN
3. 按 << 鍵，移動頻率命令位數；以改變個位數為例。	Hz V A 60.00 CRG RUN
4. 按 ▲ 鍵頻率命令加1。	Hz V A 61.00 CRG RUN
5. 按 ▼ 鍵頻率命令減1。	Hz V A 60.00 CRG RUN
6. 設定需要頻率後，五秒內按 FUNC DATA 鍵儲存。	

註：淺色代表閃爍。

- 在監看模式下以 **▲**、**▼** 鍵來控制頻率的高、低。
- 設定需求頻率後，於5秒內(即LED數值閃爍狀態下)按下 **FUNC DATA** 鍵便可完成儲存動作；若未儲存，則五秒後回到監看模式，將於3分鐘後自動儲存；若未超過3分鐘即斷電將自動回復原來設定(請參考設定項次F1.07)。

3-1-7 變頻器啟動、停止

按 **RUN** 及 **STOP/RESET** 鍵來控制變頻器的動作，如下圖所示：



3-1-8 SPEC多機能參數設定為正/反轉功能

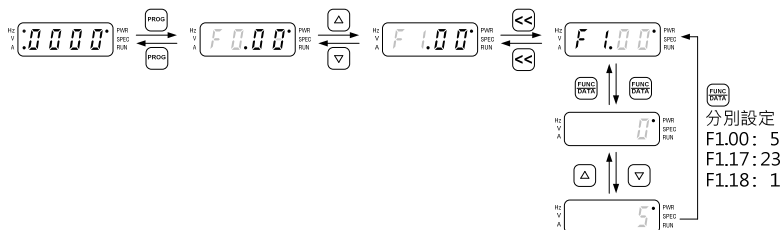

註：淺色代表閃爍

3 操作面板及遠端操作器設定

3-1-9 儲存、恢復設定值

a. 儲存變頻器設定項次資料：

操作步驟	顯示
1. 按 PROG 鍵進入設定項次選擇模式。	Hz V A CRG RUN
2. 按 << 鍵切換至項次編號。	Hz V A CRG RUN
3. 按 ▼ 鍵移動設定項次至F0.20。	Hz V A CRG RUN
4. 按 FUNC DATA 鍵進入參數設定模式。	Hz V A CRG RUN
5. 按 ▲ 鍵切換設定資料至“SAV”。	Hz V A CRG RUN
6. 按 FUNC DATA 鍵儲存，約二秒儲存完畢後顯示“End”。	Hz V A CRG RUN
7. 顯示“End”約一秒後，回到設定項次選擇模式。	Hz V A CRG RUN
8. 按 PROG 鍵回到監看模式(頻率命令)。	Hz V A CRG RUN

b. 恢復變頻器設定項次資料：

操作步驟	顯示
1. 按 PROG 鍵進入設定項次選擇模式。	Hz V A CRG RUN
2. 按 << 鍵切換至項次編號。	Hz V A CRG RUN
3. 按 ▼ 鍵移動設定項次至F0.20。	Hz V A CRG RUN
4. 按 FUNC DATA 鍵進入參數設定模式。	Hz V A CRG RUN
5. 按 ▲ 鍵切換設定資料至“rES”。	Hz V A CRG RUN
6. 按 FUNC DATA 鍵儲存，約二秒儲存完畢後顯示“End”。	Hz V A CRG RUN
7. 顯示“End”約一秒後，自動回到設定項次選擇模式。	Hz V A CRG RUN
8. 按 PROG 鍵回到監看模式(頻率命令)。	Hz V A CRG RUN

4 設定項次一覽表

簡易參數群組表(F0.18=0)		完整參數群組表(F0.18=1)		
群組	功能		群組	功能
F0	系統參數(簡易)		F0	系統參數 參數密碼 異常履歷
F1	控制設定(簡易) 畫面設定(簡易) SPEC鍵設定 停止方法 載波設定(簡易)		F1	控制設定 畫面設定 SPEC鍵設定 停止方法 載波設定
F2	頻率參數	變頻器的主速度與寸動 主速度加減速時間 V/F曲線設定 輸出頻率上下限	F2	頻率參數 變頻器主速度與多段速度 主速度與多段加減速時間 V/F曲線設定(含轉折點) 跳躍頻率 輸出頻率上下限
F4	保護參數	馬達過載	F3	控制參數 緩行頻率與時間 失速防止設定 馬達滑差補償 AVR補償 直流制動 瞬停復電後再運轉 速度追蹤
F5	多機能參數	多機能輸入功能 多機能輸出功能	F4	保護參數 變頻器過載 馬達過載 變頻器過熱保護 設定過負載保護
			F5	多機能參數 類比輸入功能 多機能輸入功能 多機能輸出功能 UP/DOWN設定 計數器計數功能 頻率偵測功能
			F6	特殊參數 Modbus通訊

5 參數設定說明

F0 系統參數

設定項次	名稱	說明	設定範圍	單位	出廠值	備註
F0.00	變頻器資訊	0: 軟體版本 1: 變頻器型號 2: 變頻器額定輸出電流 3: 變頻器運轉時數 4: 變頻器送電時數 5: 程式檢查碼	—	—	—	
F0.01	參數鎖定	0: 參數可更改 1: 參數不可更改	0, 1	—	0	
F0.02	保留	保留	—	—	—	註9
F0.03	保留	保留	—	—	—	註9
F0.04	保留	保留	—	—	—	註9
F0.05	電源電壓設定	以電源電壓(R,S,T)值設定	100.0~120.0 (註3)	0.1V	110.0 (註3)	註9
			190.0~240.0 (註4)		220.0 (註4)	
			340.0~480.0 (註5)		380.0 (註5)	
F0.08	異常履歷1		—	—	—	註9
F0.09	保留	0: 異常時異常碼	—	—	—	註9
F0.10	保留	1: 異常時輸出電流	—	—	—	註9
F0.11	保留	2: 異常時DC bus電壓	—	—	—	註9
F0.12	保留	3: 異常保護跳脫頻率	—	—	—	註9
F0.13	保留		—	—	—	註9
F0.18	設定模式	0: 簡易模式 1: 完整模式	0,1	1	0	
F0.19	保留	保留	—	—	—	註9
F0.20	變頻器公用參數	0: 無效	—	—	0	
		CLF: 清除異常履歷				
		dF60: 將變頻器恢復成60Hz出廠值				
		dF50: 將變頻器恢復成50Hz出廠值				
		SAv: 儲存設定值				
		rES: 恢復設定值				

底色為 設定項次: 代表運轉中可設定。

F1 操作參數

設定項次	名稱	說明		設定範圍	單位	出廠值	備註
F1.00	啟動控制 選擇		啟動命令	運轉方向	0~11	—	3
		0	正、反轉指令控制	正、反轉指令控制			
		1	正轉指令控制	反轉指令控制			
		2	操作面板設定	正、反轉指令控制			
		3		正轉方向			
		4		反轉方向			
		5		反轉指令控制			
		6~7	保留	保留			
		8	通訊控制	通訊控制			
		9	通訊控制	反轉指令控制			
		10	正轉指令控制	通訊控制			
		11	操作面板設定	通訊控制			
F1.01	主頻率 命令選擇	0: 頻率命令由(F1.03)類比輸入源選擇 1: 頻率命令由操作面板設定 2: 保留 3: 線速度(MPM)由操作面板設定 4: 多機能端子 UP/DOWN 指令控制 5: 頻率命令由通訊設定		0~5	—	1	
F1.02	副頻率 命令選擇	0: 頻率命令由(F1.03)類比輸入源選擇 1: 頻率命令由操作面板設定 2: 多機能端子UP/DOWN指令設定		0~2	—	0	註9
F1.03	類比輸入源 選擇	0: Pot+AI 1: Pot-AI 2: AI-Pot 3: Pot 或 AI (由多機能輸入端子切換) 4: Pot 5: AI		0~5	—	0	
F1.04	Pot 輸入源 選擇	0: 操作面板 Pot 設定旋鈕 1: 保留		0	—	0	註9
F1.05	保留	保留		—	—	—	註9
F1.06	操作面板 頻率命令 設定選擇	0: 在監看模式下, 不可更改頻率命令 1: 在監看模式下, 可更改頻率命令		0, 1	—	1	註9
F1.07	保留	保留		—	—	—	註9

底色為 設定項次：代表運轉中可設定。

5 參數設定說明

設定項次	名稱	說明	設定範圍	單位	出廠值	備註
F1.08	主畫面顯示選擇	操作面板有 8 種顯示狀態，選擇其中之一作為主畫面顯示狀態 1：輸出頻率 2：頻率命令 3：輸出電壓 4：DC bus 電壓 5：輸出電流 6：端子狀態 7：散熱片溫度 8：畫面顯示 8	1~8	—	1	
F1.09	保留	0：端子狀態 1：變頻器溫度 2：馬達轉速(RPM) 3：線速度(MPM)	—	—	—	註 9
F1.10	保留	4：程序運轉階段 5：程序運轉週期 6：計數值 7：電流限制準位	—	—	—	註 9
F1.11	畫面顯示 8	8：主頻率命令 9：副頻率命令 10：保留 11：保留	0~11	—	2	註 9
F1.12	保留	保留	—	—	—	註 9
F1.13	線速度設定值	決定操作面板的線速度 MPM 顯示值	0.00~500.00	0.01	20.00	
F1.14	線速度顯示值小數位數	線速度 MPM 顯示值的小數位數	0~3	—	0	
F1.17	SPEC 鍵設定	功能與多機能輸入設定相同	-28 ~ +28 (註7)	—	0	
F1.18	SPEC 鍵自保持功能選擇	0：無 1：有	0, 1	—	0	
F1.19	停止方法	0：減速停止+直流制動 1：自由運轉停止 2：自由運轉停止+直流制動	0~2	—	0	

底色為 設定項次：代表運轉中可設定。

設定項次	名稱	說明	設定範圍	單位	出廠值	備註
F1.20	禁止反轉	0：可反轉 1：不可反轉	0, 1	—	0	註9
F1.21	載波頻率	設定值越大，運轉噪音越小	0~6	—	2 (註8)	
F1.22	過負載降波模式	0：載波不隨負載電流大小調整 1：載波隨負載電流大小調整	0, 1	—	1	註9
F1.23	異常保護自動復歸次數選擇	異常狀況發生時，自動復歸次數	0~16	1次	0	註9

底色為 設定項次：代表運轉中可設定。

5 參數設定說明

F2 頻率參數

設定項次	名稱	說明			設定範圍	單位	出廠值	備註
F2.00	主速度 (第一段速)	多段指令 3	多段指令 2	多段指令 1	0.00~400.00	0.01Hz	50.00 (註1)	
		OFF	OFF	OFF			60.00 (註2)	
F2.01	第二段速	OFF	OFF	ON	0.00~400.00	0.01Hz	10.00	註9
F2.02	第三段速	OFF	ON	OFF	0.00~400.00	0.01Hz	20.00	註9
F2.03	第四段速	OFF	ON	ON	0.00~400.00	0.01Hz	30.00	註9
F2.04	第五段速	ON	OFF	OFF	0.00~400.00	0.01Hz	0.00	註9
F2.05	第六段速	ON	OFF	ON	0.00~400.00	0.01Hz	0.00	註9
F2.06	第七段速	ON	ON	OFF	0.00~400.00	0.01Hz	0.00	註9
F2.07	第八段速	ON	ON	ON	0.00~400.00	0.01Hz	0.00	註9
F2.16	寸動速度	寸動速度			0.00~400.00	0.01Hz	6.00	
F2.17	加、減速 基準頻率	加、減速時間所對應之頻率			0.01~400.00	0.01Hz	50.00 (註1) 60.00 (註2)	註9
F2.18	主加速時間	主速度，第五速度~第十六速度及寸動速度的加速時間			0.0~3200.0	0.1sec	5.0	
F2.19	主減速時間	主速度，第五速度~第十六速度及寸動速度的減速時間			0.0~3200.0	0.1sec	5.0	
F2.20	第二段 加速時間	第二段速度的加速時間			0.0~3200.0	0.1sec	5.0	註9
F2.21	第二段 減速時間	第二段速度的減速時間			0.0~3200.0	0.1sec	5.0	註9
F2.22	保留	保留			—	—	—	註9
F2.23	保留	保留			—	—	—	註9
F2.24	保留	保留			—	—	—	註9
F2.25	保留	保留			—	—	—	註9
F2.26	副加速時間	由多機能輸入端子選擇副加速時間			0.0~3200.0	0.1sec	5.0	註9
F2.27	副減速時間	由多機能輸入端子選擇副減速時間			0.0~3200.0	0.1sec	5.0	註9
F2.28	S字加/減速 時間	加、減速之啟動及到達期間作緩慢加/減速動作			0.0~5.0	0.1sec	0.0	註9
F2.30	保留	保留			—	—	—	註9
F2.31	V/F曲線選擇	0：直線 1：省能源裝置，依負載輕重自動作V/F調整 2：2次方曲線 3：1.7次方曲線 4：1.5次方曲線			0~4	—	0	註9

底色為 設定項次：代表運轉中可設定。

設定項次	名稱	說明	設定範圍	單位	出廠值	備註
F2.32	最大輸出頻率	變頻器可操作之最大頻率	0.1~400.0	0.1Hz	50.0 (註1) 60.0 (註2)	
F2.33	起動頻率	變頻器的起動頻率	0.1~10.0	0.1Hz	0.5	註9
F2.34	起動電壓	對應起動頻率之輸出電壓	0.1~50.0 (註3,4) 0.1~100.0 (註5)	0.1V _{AC}	8.0 (註3,4) 12.0 (註5)	
F2.35	基底頻率	V/F曲線最大電壓之對應頻率	0.1~400.0	0.1Hz	50.0 (註1) 60.0 (註2)	
F2.36	基底電壓	V/F曲線最大電壓之設定	0.1~255.0 (註3,4) 0.1~510.0 (註5)	0.1V _{AC}	220.0 (註3,4) 380.0 (註5)	
F2.37	第一轉折點頻率	V/F曲線第一轉折點之頻率	0.0~399.9	0.1Hz	0.0	註9
F2.38	第一轉折點電壓	V/F曲線第一轉折點之電壓	0.0~255.0 (註3,4) 0.0~510.0 (註5)	0.1V _{AC}	0.0	註9
F2.39	第二轉折點頻率	V/F曲線第二轉折點之頻率	0.0~399.9	0.1Hz	0.0	註9
F2.40	第二轉折點電壓	V/F曲線第二轉折點之電壓	0.0~255.0 (註3,4) 0.0~510.0 (註5)	0.1V _{AC}	0.0	註9
F2.42	跳躍頻率1	防止機械負載發生共振，頻率設定值 越過跳躍區間1	0.0~400.0	0.1Hz	0.0	註9
F2.43	跳躍頻率2	防止負載機械發生共振，頻率設定值 越過跳躍區間2	0.0~400.0	0.1Hz	0.0	註9
F2.44	跳躍頻率3	防止負載機械發生共振，頻率設定值 越過跳躍區間3	0.0~400.0	0.1Hz	0.0	註9
F2.45	跳躍頻率區間	跳躍頻率1、2、3之跳躍區間設定	0.0~25.5	0.1Hz	0.0	註9
F2.47	頻率上限值	輸出頻率的上限值(1.00=最大輸出頻率)	0.00~1.00	0.01	1.00	
F2.48	頻率下限值	輸出頻率的下限值(1.00=最大輸出頻率)	0.00~1.00	0.01	0.00	

底色為 設定項次：代表運轉中可設定。

5 參數設定說明

F3 控制參數

設定項次	名稱	說明	設定範圍	單位	出廠值	備註
F3.00	緩行頻率	變頻器加速至緩行頻率下作等速運轉	0.0~400.0	0.1Hz	0.5	註9
F3.01	緩行時間	變頻器在緩行頻率下等速運轉的時間	0.0~360.0	0.1sec	0.0	註9
F3.03	加速中 失速防止準位	加速狀態下，失速防止處理方式為等速運轉 (200%：關閉)	30%~200% 之變頻器 額定電流	1%	170	註9
F3.04	等速中 失速防止準位	等速狀態下，失速防止處理方式為降速運轉 (200%：關閉)	30%~200% 之變頻器 額定電流	1%	160	註9
F3.05	等速中 失速防止 加速時間設定	等速失速防止回復時，輸出頻率的加速時間	0.1~3200.0	0.1sec	5.0	註9
F3.06	等速中 失速防止 減速時間設定	等速失速防止時，輸出頻率的減速時間	0.1~3200.0	0.1sec	5.0	註9
F3.07	減速中 失速防止選擇	0：減速中失速防止機能無作用 1：減速中失速防止機能有作用	0, 1	—	1	註9
F3.09	馬達滑差補償	依馬達不同負載下的滑差作補償，以期達到恆定轉速 (0.0：關閉)	-59.9~60.0	0.1Hz	0.0	註9
F3.10	滑差補償之 頻率響應時間	設定馬達滑差補償的償響應時間，單位時間：5ms	1~255	5ms	40	註9
F3.12	自動轉矩 提昇增益	隨負載轉矩變動，調整V/F電壓輸出 (0.0：關閉)	0.0~25.5	0.1	1.0	註9
F3.13	自動轉矩提升 增益響應時間	設定自動轉矩補償的響應時間	1~255	1ms	60	註9
F3.18	AVR設定	0：無 1：有	0, 1	—	1	註9
F3.19	AVR 響應時間	設定AVR電壓調整量的響應時間	0~255	1ms	50	註9

底色為 設定項次：代表運轉中可設定。

設定項次	名稱	說明	設定範圍	單位	出廠值	備註
F3.21	直流制動能力設定	直流制動時的電流準位	0~150% 之變頻器 額定電流	1%	50	註9
F3.22	直流制動反應時間	依直流制動情形增減反應時間	1~255	1ms	10	註9
F3.23	啟動時直流制動時間	加速啟動時，直流制動時間	0.0~60.0	0.1sec	0.0	註9
F3.24	停止時直流制動時間	降速停止時，直流制動時間	0.0~60.0	0.1sec	0.5	註9
F3.25	停止直流制動頻率	直流制動動作頻率點	0.1~60.0	0.1Hz	0.5	註9
F3.27	動態煞車之動作準位	當DC bus電壓大於設定準位時， 動態煞車動作(200V級設410V/400V 級設820V：關閉)	350~410 (註3,4)	1V _{DC}	390 (註3,4)	註9
			700~820 (註5)		760 (註5)	
F3.30	瞬停復電後再運轉選擇	0：瞬停復電後不可再起動 1：瞬停復電後可再起動 2：斷電降速停止 3：斷電降速復電後可再起動	0~3	—	0	註9
F3.31	斷電降速電壓準位設定	當電源電壓低於準位時，則降速停止	75.0~96.0 (註3)	0.1V _{ac}	87.5 (註3)	註9
			150.0~192.0 (註4)		175.0 (註4)	
			300.0~384.0 (註5)		320.0 (註5)	
F3.32	斷電降速之減算頻率	斷電降速時，頻率=輸出頻率-減算頻率	0.0~20.0	0.1Hz	3.0	註9
F3.33	斷電降速之減速時間1	輸出頻率大於切換頻率(F3.35)的減速時間	0.0~3200.0	0.1sec	5.0	註9
F3.34	斷電降速之減速時間2	輸出頻率小於切換頻率(F3.35)的減速時間	0.0~3200.0	0.1sec	5.0	註9

5 參數設定說明

設定項次	名稱	說明	設定範圍	單位	出廠值	備註
F3.35	斷電降速之 切換頻率	兩段減速時間切換之頻率設定值	0.0~400.0	0.1Hz	0.0	註9
F3.37	速度追蹤 電流準位	當電流大於速度追蹤電流時，輸出 頻率開始向下搜尋	0~200% 之變頻器 額定電流	1%	150	註9
F3.38	速度追蹤前之 遮斷時間	速度追蹤前之遮斷輸出時間	0.1~60.0	0.1sec	0.5	註9
F3.39	速度追蹤的 V/F	速度追蹤動作中所設定的V/F 百分比電壓輸出	0~100%	1%	100	註9

底色為 設定項次：代表運轉中可設定。

F4 保護參數

設定項次	名稱	說明	設定範圍	單位	出廠值	備註
F4.07	馬達 過載保護選擇	0：馬達過載保護無效 1：馬達過載保護有效(OL) 2：獨立散熱風扇馬達過載保護有效(OL)	0~2	—	1	註9
F4.08	馬達額定電流	依馬達實際額定電流設定	10%~150% 之變頻器 額定電流	0.1A	依各馬 力數之 馬達額定 電流	
F4.09	馬達無載電流	依馬達無載下的輸出電流設定	0~馬達額定 電流值	0.1A	1/3之馬達 額定 電流值	註9
F4.10	馬達過載 跳脫時間	設定馬達過載(馬達額定電流的150%) 的跳脫時間	0.5~10.0	0.1min	5.0	註9
F4.12	變頻器 過熱跳脫 保護準位	設定過熱跳脫(OH)的動作準位	85~115	1℃	90 (註6)	註9
F4.13	變頻器過熱 警示選擇	0：無 1：過熱警示(OHt)，持續運轉(relay 檢出) 2：過熱警示(OHt)，降載波運轉(relay 檢出) 3：過熱警示(OHt)，停止運轉(relay 檢出)	0~3	—	2	註9
F4.14	變頻器過熱 警示準位	設定過熱警示的動作準位	45~105	1℃	70	註9
F4.15	變頻器 溫度遲滯區間	過熱警示及風扇動作的溫度遲滯區間	0.1~10.0	0.1℃	3.0	註9
F4.17	保留	保留	—	—	—	註9
F4.18	保留	保留	—	—	—	註9

底色為 設定項次：代表運轉中可設定。

5 參數設定說明

設定項次	名稱	說明	設定範圍	單位	出廠值	備註
F4.19	保留	保留	—	—	—	註9
F4.21	保留	保留	—	—	—	註9
F4.22	保留	保留	—	—	—	註9
F4.23	保留	保留	—	—	—	註9
F4.25	系統過負載 檢出設定	0：無過負載檢出 1：有過負載檢出(OLO)	0, 1	—	0	註9
F4.26	系統過負載 檢出狀態	0：頻率等速才檢出 1：運轉中檢出	0, 1	—	0	註9
F4.27	系統過負載 後輸出設定	0：檢出過負載後可繼續運轉 1：檢出過負載後異常跳脫	0, 1	—	0	註9
F4.28	系統過負載 檢出準位	過負載檢出功能之電流設定準位	30%~200% 之變頻器 額定電流	1%	160	註9
F4.29	系統過負載 檢出時間	電流大於(F4.28)過負載檢出準位連續 檢測超過檢出時間，過負載檢出	0.1~300.0	0.1sec	0.1	註9
F4.36	保留	保留	—	—	—	註9
F4.37	保留	保留	—	—	—	註9
F4.38	保留	保留	—	—	—	註9
F4.39	保留	保留	—	—	—	註9

底色為 設定項次：代表運轉中可設定。

F5 多機能參數

設定項次	名稱	說明	設定範圍	單位	出廠值	備註
F5.00	類比輸入 Pot選擇	0：類比輸入增益 1：頻率命令 2：電流限制 3：V/F獨立調整之V	0~3	—	1	註9
F5.01	類比輸入 AI選擇	0：類比輸入增益 1：頻率命令 2：電流限制 3：V/F獨立調整之V 4：PTC溫度 5：PID回授	0~5	—	1	註9
F5.02	AI選擇	0：4~20mA (2~10V) 1：0~20mA (0~10V)	0, 1	—	1	註9
F5.03	類比輸入 Pot增益比	類比輸入Pot增益比	0.00~2.00	0.01	1.00	註9
F5.04	類比輸入 Pot偏壓比	類比輸入Pot偏壓比	-1.00~1.00	0.01	0.00	註9
F5.05	類比輸入 AI增益比	類比輸入AI增益比	0.00~2.00	0.01	1.00	註9
F5.06	類比輸入 AI偏壓比	類比輸入AI偏壓比	-1.00~1.00	0.01	0.00	註9
F5.07	類比頻率 濾波設定	針對類比輸入設定為頻率命令時做信號濾波	0~255	1	20	註9
F5.08	類比頻率 不感帶設定	適度增加不感帶區可增加頻率命令的穩定性，但會降低微調線性度	0.00~2.55	0.01Hz	0.00	註9
F5.09	V的加速時間	V/F獨立調整之V的加速時間	0.0~3200.0	0.1sec	5.0	註9
F5.10	V的減速時間	V/F獨立調整之V的減速時間	0.0~3200.0	0.1sec	5.0	註9

底色為 設定項次：代表運轉中可設定。

5 參數設定說明

設定項次	名稱	說明	設定範圍	單位	出廠值	備註
F5.19	端子X1 多機能 輸入設定	0：無作用 ±1：寸動指令 ±2：副加，減速指令切換 ±3：多段指令1 ±4：多段指令2 ±5：多段指令3 ±6：-	-28 ~ +28 (註7)	-	22	
F5.20	端子X2 多機能 輸入設定	±7：重置指令 ±8：外部異常指令(EF) ±9：遮斷輸出指令(bb) ±10：自由運轉停止指令(Fr) ±11：由最大頻率作速度尋找 ±12：由頻率命令作速度尋找	-28 ~ +28 (註7)	-	23	
F5.21	端子X3 多機能 輸入設定	±13：加/減速禁止指令 ±14：UP指令 ±15：DOWN指令 ±16：UP/DOWN頻率命令清除 ±17：UP/DOWN 頻率命令確認 ±18：選擇類比輸入源(Pot/AI) ±19：主副頻率命令選擇 ±20：程序運轉啟動指令輸入 ±21：程序運轉暫停指令輸入 ±22：正轉 ±23：反轉 ±24：三線自保持 STOP 指令 ±25：直流制動允許(停止時) ±26：計數輸入 ±27：計數清除 ±28：電流限制允許	-28 ~ +28 (註7)	-	1	
F5.25	數位入力 反應時間	當輸入信號小於設定時間，則軟體 不接受	1~255	1ms	10	註9

底色為 設定項次：代表運轉中可設定。

設定項次	名稱	說明	設定範圍	單位	出廠值	備註
F5.26	端子 Y1(TA/TC) 多機能 輸出設定	0：無作用 ±1：運轉中檢出 ±2：等速檢出 ±3：零速中檢出 ±4：頻率偵測 ±5：系統過負載檢出(OLO) ±6：失速防止檢出 ±7：低電壓檢出(LE) ±8：煞車晶體動作檢出(db) ±9：瞬停復電再起動動作中檢出 ±10：異常再起動動作中檢出 ±11：異常信號檢出 ±12：程序運轉檢出 ±13：程序運轉一階段運轉完成檢出 ±14：程序運轉一週期運轉完成檢出 ±15：程序運轉暫停檢出 ±16：計數值到達檢出1 ±17：計數值到達檢出2 ±18：反轉檢出 ±19：變頻器過熱警示檢出(OHt) ±20：風扇運轉檢出 ±21：外接PTC過熱警示檢出(OH1)	-21~+21 (註7)	—	11	
F5.30	UP/DOWN 控制記憶選擇	0：斷電清除記憶 1：斷電記憶	0, 1	—	0	註9
F5.31	UP/DOWN 微調頻率	0：0.01Hz 1~8：*0.05Hz 9：0.5Hz 10~250：*0.1Hz	0~250	—	0	註9
F5.32	UP/DOWN 微調時間	1~5：端子微調反應時間，超過即連續 加/減速 6：邊緣觸發	1~6	—	1	註9
F5.33	UP/DOWN 頻率命令調整	直接以KEYPAD調整頻率	0.00~400.00	0.01Hz	0.00	註9

底色為 設定項次：代表運轉中可設定。

5 參數設定說明

設定項次	名稱	說明	設定範圍	單位	出廠值	備註
F5.35	計數值模式	0：上數模式 1：下數模式	0、1	—	0	註9
F5.36	計數值 到達設定1	計數值到達設定1	0~9999	1	0	註9
F5.37	計數值 到達設定2	計數值到達設定2	0~9999	1	0	註9
F5.39	等速檢出範圍	等速檢出的頻寬範圍	0.0~10.0	0.1Hz	2.0	註9
F5.40	頻率偵測範圍	頻率偵測的頻寬範圍	0.0~10.0	0.1Hz	2.0	註9
F5.41	頻率偵測準位	多機能輸出端子之頻率偵測準位	0.0~400.0	0.1Hz	0.0	註9

F6 特殊參數

設定項次	名稱	說明	設定範圍	單位	出廠值	備註
F6.55	通訊位址	副機以此位址來接受及回傳訊息 (0, 無作用)	0~254	—	0	註 9
F6.56	通訊 傳輸速率	0: 4800bps 1: 9600bps 2: 19200bps	0~2	—	1	註 9
F6.57	通訊格式	0: 8,N,2 1: 8,E,1 2: 8,O,1	0~2	—	1	註 9
F6.58	通訊逾時 設定(Cot)	副機接受訊息的間隔時間, 大於設定 時間則作通訊逾時檢出 (0.0, 不作檢 出)	0.0~100.0	0.1sec	0.0	註 9
F6.59	通訊 逾時處理	0: 警告並繼續運轉 1: 警告並減速停止 2: 警告並自由運轉停止	0~2	—	0	註 9
F6.60	多機能輸入控 制選擇	0: 多機能輸入由多機能端子控制 1: 多機能輸入由通訊控制	0, 1	—	0	註 9

底色為 設定項次: 代表運轉中可設定。

備註:

1. 50Hz的出廠值
2. 60Hz的出廠值
3. 100V電壓規格
4. 200V電壓規格
5. 400V電壓規格
6. +: 代表a(常開)接點, -: 代表b(常閉)接點。
多機能輸入端子用於UP/DOWN控制時, 接線長度不可超過20公尺。
8. 載波頻率(F1.21)設定值超過4時, 應降額使用或改用較大容量之變頻器。
9. 需將F0.18設定為1, 該功能才可設定。

5 參數設定說明

5 參數設定說明

F0 系統參數

【F0.00】變頻器資訊

- 可顯示變頻器馬力數與軟體版本訊息。
使用者監看此參數是否與驅動器容量相符合。
- 此說明書必須與軟體編號相同。
不同軟體編號的變頻器，不可以交互做複製的動作，操作面板會顯示Wr_F。
- 操作面板的LED燈來分別指示各項顯示內容，LED燈顯示各項內容如下：

Hz	V	A	
<input type="radio"/>	<input type="radio"/>	<input type="radio"/>	軟體版本
<input checked="" type="radio"/>	<input type="radio"/>	<input type="radio"/>	變頻器型號
<input type="radio"/>	<input checked="" type="radio"/>	<input type="radio"/>	變頻器額定輸出電流
<input checked="" type="radio"/>	<input checked="" type="radio"/>	<input type="radio"/>	變頻器運轉時數(小時)
<input type="radio"/>	<input type="radio"/>	<input checked="" type="radio"/>	變頻器送電時數(小時)
<input checked="" type="radio"/>	<input type="radio"/>	<input checked="" type="radio"/>	程式檢查碼

- 200V單相機種馬力數第二碼標示為S。

【F0.01】參數鎖定

- 保護目前參數設定值，防止參數被不當設定導致系統不正常。
- 設定內容如下：
0：參數可更改
1：參數不可更改

【F0.05】電源電壓設定

- 設定內容如下：

電壓標準規格	範圍
100V系列	100.0~120.0V
200V系列	190.0~240.0V
400V系列	340.0~480.0V

- 務必依實際電源電壓設定，此設定會影響LE及LE1動作準位和V/F正確輸出。

【F0.08】異常履歷1

- 共6組異常履歷，可分別記錄異常時4種狀態(異常碼、異常時輸出電流、異常時DC bus電壓、異常時輸出頻率)，最近一次至前六次異常履歷記錄於F0.08~F0.13。
- 顯示內容如下：
0：異常時異常碼
1：異常時輸出電流
2：異常時DC bus電壓
3：異常時輸出頻率

【F0.18】設定模式

- 0：簡易模式時隱藏部份功能
- 1：完整模式時可設定所有功能項

【F0.20】變頻器公用參數

a. 設定內容如下：

8880	無效
0000	清除異常履歷
6660	將變頻器恢復成60Hz出廠值
5550	將變頻器恢復成50Hz出廠值
588	儲存設定值
885	恢復設定值
8888	參數讀出 (變頻器→操作器)
8888	參數寫入 (操作器→變頻器)

b. 參數設定後請務必以SAV定此項儲存，方便未來參數之還原。

5 參數設定說明

F1 操作參數

【F1.00】 啟動控制選擇

a. F1.00 = 0

- (1) 多機能輸入端子(X1~X4)選擇正轉指令端子及反轉指令端子。
- (2) 啟動命令及運轉方向皆由正轉指令端子或反轉指令端子控制。
- (3) 正轉指令端子、反轉指令端子同時短路或開路時，停止運轉。

例：設定值：F5.19=22、F5.20=23

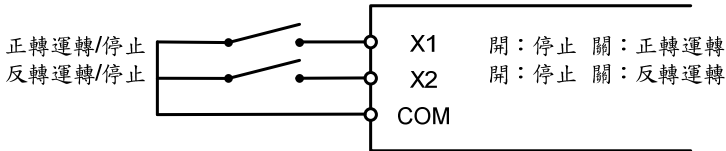

b. F1.00 = 1

- (1) 多機能輸入端子(X1~X4)選擇正轉指令端子及反轉指令端子。
- (2) 啟動命令由正轉指令端子控制；運轉方向由反轉指令端子控制。

例：設定值：F5.19=22、F5.20=23

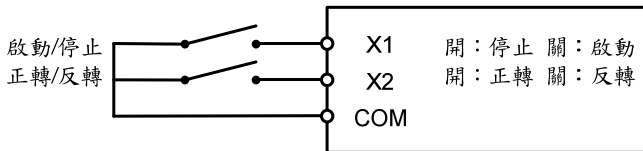

c. F1.00 = 2

- (1) 多機能輸入端子(X1~X4)選擇正轉指令端子及反轉指令端子。
- (2) 啟動命令由操作面板控制；運轉方向由正轉指令端子及反轉指令端子控制。
- (3) 正轉指令、反轉指令端子同時短路或開路時，停止運轉。

例：設定值：F5.19=22、F5.20=23

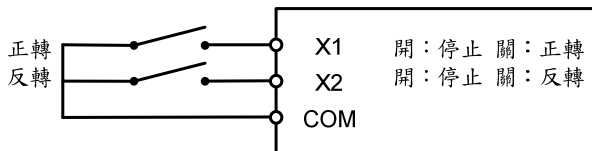

d. F1.00 = 3

- (1) 啟動命令由操作面板控制；運轉方向固定正轉。
- (2) 正轉指令、反轉指令端子無作用。

e. F1.00 = 4

- (1) 啟動命令由操作面板控制；運轉方向固定反轉。
- (2) 正轉指令、反轉指令端子無作用。

f. F1.00 = 5

- (1) 多機能輸入端子(X1~X4)選擇反轉指令端子。
- (2) 啟動命令由操作面板控制；運轉方向由反轉指令端子控制。

例：設定值：F5.19=23

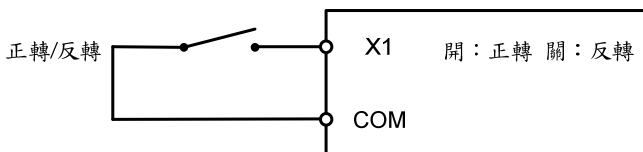

g. F1.00 = 6~7

保留

h. F1.00 = 8

- (1) 啟動命令及運轉方向皆由通訊控制。
- (2) 正轉指令、反轉指令端子無作用。

i. F1.00 = 9

- (1) 多機能輸入端子(X1~X4)選擇反轉指令端子。
- (2) 啟動命令由通訊控制；運轉方向由反轉指令端子控制。

j. F1.00 = 10

- (1) 多機能輸入端子(X1~X4)選擇反轉指令。
- (2) 啟動命令由正轉指令端子控制；運轉方向由通訊控制。
- (3) 反轉指令端子無作用。

k. F1.00 = 11

- (1) 啟動命令由操作面板控制；運轉方向由通訊控制。
- (2) 正轉指令、反轉指令端子無作用。

5 參數設定說明

※ 當F1.00 = 0或2時

若正轉指令端子和反轉指令端子同時開路時，監看模式的頻率畫面會顯示'----'與監看畫面值交替閃爍。

若正轉指令端子和反轉指令端子同時短路時，監看模式的頻率畫面會顯示'dtF'閃爍。

※ 運轉方向為反轉時，輸出頻率顯示“-”，反轉指示燈亮起。

【F1.01】 主頻率命令選擇

a. F1.01 = 0

頻率由類比輸入端子控制(由F1.03選擇Pot、AI類比輸入源)。

(1) Pot:

頻率範圍的增益比及偏壓比可參照F5.03、F5.04的設定。

(2) AI-GND:

頻率範圍的增益比及偏壓比可參照F5.05、F5.06的設定。

由JP1選擇輸入模式

JP1→I模式:

輸入電流源範圍4~20mA或0~20mA (由F5.02選擇)。

JP1→V模式:

輸入電壓源範圍2~10V或0~10V (由F5.02選擇)。

b. F1.01 = 1

由操作面板設定頻率命令，在操作面板上，由項次F2.00設定頻率，亦可在監看模式以▲▼鍵作頻率設定。

c. F1.01 = 3

由操作面板設定MPM命令。

d. F1.01 = 4

UP/DOWN端子控制

由多機能輸入端子選擇(UP指令，DOWN指令，UP/DOWN頻率命令清除，UP/DOWN頻率命令確認)。

e. F1.01 = 5

頻率命令由通訊設定。

※ F1.01 = 1~3，在監看模式下，按▲或▼一下，頻率命令會閃爍，但是不會改變頻率命令，若再立即按一次，即可以開始更改頻率命令。

【F1.02】 副頻率命令選擇

可由F5.19~F5.22設定為±19，利用多機能輸入端子切換主／副頻率命令。

設定內容如下：(參考第F1.01設定說明)

- 0：類比輸入設定
- 1：操作面板設定
- 2：UP/DOWN設定

【F1.03】 類比輸入源選擇

設定內容如下：(參考第F5.00~F5.01設定說明)

- 0：Pot+AI
- 1：Pot-AI
- 2：AI-Pot
- 3：Pot 或 AI(由多機能輸入端子切換)
- 4：Pot
- 5：AI

※ Pot為操作面板旋鈕、AI為類比輸入端子。

【F1.04】 Pot 輸入源選擇

設定內容如下：

- 0：變頻器操作面板 Pot 設定旋鈕
- 1：外部遠端操作器(KP-601) Pot 設定旋鈕

b. STOP鍵使用方法

(1) STOP鍵當緊急停止使用：

當變頻器啟動與運轉方向由輸入端子控制時(F1.00=0、1或10)，在變頻器運轉期間按下STOP鍵，則輸出頻率降至0.00Hz，操作面板顯示 $\overset{Hz}{\Delta} \boxed{0.00} \overset{CRG}{\Delta} \text{RUN}$ ；重新再起動的方法是將啟動命令解除，再重新起動。

(2) STOP鍵為一般停止使用：

F1.00=2、3、4、5、11時，啟動 $\boxed{\text{RUN}}$ 由控制，停止由 $\boxed{\text{STOP/RESET}}$ 控制。

【F1.06】 操作面板頻率命令設定選擇

設定內容如下：

- 0：操作面板在監看模式下，不可更改頻率命令，可避免在監看模式下，因更改頻率而產生錯誤。
- 1：操作面板在監看模式下，可更改頻率命令。

5 參數設定說明

【F1.08】主畫面顯示選擇

a. 設定內容如下：

- 1：輸出頻率
- 2：頻率命令
- 3：輸出電壓
- 4：DC bus電壓
- 5：輸出電流
- 6：端子狀態
- 7：變頻器溫度
- 8：畫面顯示8 (F1.11)

b. 可設定以上任何一個為主畫面，其他為輔助畫面。

c. 當在輔助畫面下，不做任何操作時，經過約3分鐘後會自動跳回主畫面。

【F1.11】輔助畫面 8

設定內容如下：

- 0：端子狀態
- 1：變頻器溫度
- 2：馬達轉速(RPM)
- 3：線速度(MPM)
- 4：程序運轉階段
- 5：程序運轉週期
- 6：計數值
- 7：電流限制單位
- 8：主頻率命令
- 9：副頻率命令
- 10：PID 命令
- 11：PID回授

【F1.13】線速度設定值

監看模式之線速度顯示

線速度=速度設定值(F1.13) × 輸出頻率

【F1.14】線速度顯示值小數點位數

需要監看細微的線速度變化時，可設定速度顯示值的小數位數(從 0~3 個小數位數)，以方便觀看。

【F1.17】SPEC 鍵設定

SPEC鍵設定與多機能輸入設定相同，請參考F5.19~F5.22設定說明。

【F1.18】 SPEC 鍵自保持功能選擇

SPEC鍵自保持功能選擇：

- 0：無自保持
- 1：有自保持

範例：將SPEC鍵作為反轉功能。

- F1.00 啟動控制設為5 (由操作面板啟動)，
- F1.17 設為23(反轉)，
- F1.18 設為1 有自保持，則運轉中按下SPEC鍵時，馬達將會反轉。

【F1.19】 停止方法

a. 設定內容如下：

- 0：減速停止+直流制動(請參考設定項次F3.21~F3.35)
- 1：自由運轉停止(慣性停止)
- 2：自由運轉停止+直流制動

b. 當F1.19=2，其停止動作如下圖所示：

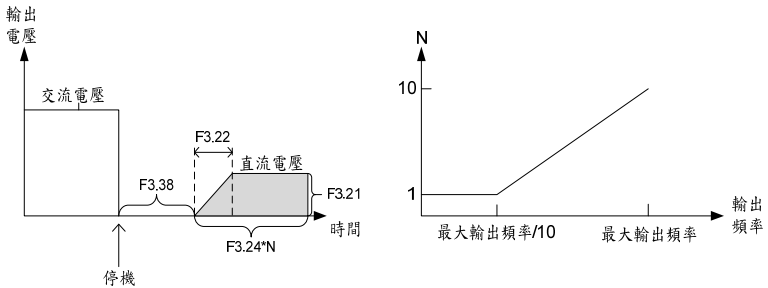

c. 直流制動時變頻器輸出電流有異常時，請適當調整F3.38時間，使馬達轉子剩磁消失，再進行直流制動。

【F1.20】 禁止反轉

設定內容如下：

- 0：可反轉
- 1：不可反轉

5 參數設定說明

【F1.21】 載波頻率

a. 設定內容如下：

設定值	載波頻率
0	800Hz
1	2.5kHz
2	5kHz
3	7.5kHz
4	10kHz
5	12.5kHz
6	16kHz

- b. 載波頻率設定值超過4時，應降額使用。
- c. 載波頻率設定值越高，噪音越小，但是必須考量變頻器與馬達之間的連線距離做適當調整。(可參考章節2-3-4配線注意事項之關係表)
- d. 隨著負載變化，載波頻率將自行調變。(如下圖所示)
- e. 載波頻率設定值愈低，雜訊干擾愈低。

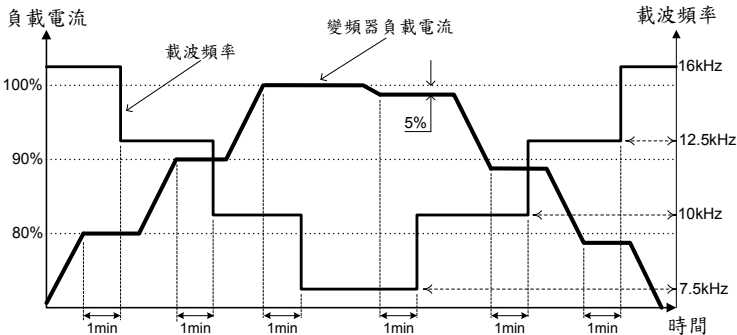

【F1.22】

F1.22=0

變頻器載波頻率維持固定，變頻器額定電流將依載波設定值調降。

變頻器過載保護曲線將依降低額定電流的準位進行OL1保護。

F1.22=1

變頻器額定電流維持固定，輸出載波頻率將隨過載輸出電流與過載時間自動調降。

<p>過負載降載 波模式 (F1.22)</p>	<p>0</p>	<p>1</p>
<p>OLI 曲線</p>	<p>跳脫時間 (min)</p> <p>1min</p> <p>3sec</p> <p>100 150 180</p> <p>輸出電流 (%)</p> <p>(150%額定 1min) (180%額定 3sec)</p>	<p>跳脫時間 (min)</p> <p>1min</p> <p>30sec</p> <p>100 150 180</p> <p>輸出電流 (%)</p> <p>(150%額定 1min) (180%額定 30sec)</p>
<p>載波限制 曲線 1</p>	<p>無</p>	<p>變頻器負載</p> <p>100%</p> <p>90%</p> <p>80%</p> <p>1sec 3sec 5min 30min</p> <p>時間</p> <p>載波限制</p> <p>10K</p> <p>13.3K</p> <p>10K</p> <p>8K</p> <p>*輸出載波頻率依減額曲線表自動調降</p>
<p>載波限制 曲線 2</p>	<p>降載波時間 (min)</p> <p>1min</p> <p>3sec</p> <p>100 150 180</p> <p>輸出電流 (%)</p>	

【F1.23】 異常保護自動復歸次數選擇

- 功用：針對OC、OE、GF異常重置及再次啟動。
- 異常再啟動次數設定0時，異常發生後不執行異常再啟動功能。

5 參數設定說明

F2 頻率參數

【F2.00】 主速度(第一段速)

【F2.07】 第八段速度

【F2.16】 寸動速度

a. 設定範圍：0.00~400.00Hz

b. 相關設定項次

(1)多段加/減速時間(F2.18~ F2.28)

(2)多機能輸入設定(F5.19~ F5.22)

c. 多段速度的產生

寸動指令	多段指令3	多段指令2	多段指令1	名稱
ON	x	x	x	寸動速度
OFF	OFF	OFF	OFF	主速度 (第一段速)
OFF	OFF	OFF	ON	第二段速
OFF	OFF	ON	OFF	第三段速
OFF	OFF	ON	ON	第四段速
OFF	ON	OFF	OFF	第五段速
OFF	ON	OFF	ON	第六段速
OFF	ON	ON	OFF	第七段速
OFF	ON	ON	ON	第八段速

※ 'x'：代表無意義(Don't care)。

※ 寸動指令 > 多段速指令 > 主速度指令。

※ 寸動指令與多段速度指令是由多機能輸入設定(F5.19~ F5.21)規劃多機能輸入端子(X1~X3)後，由端子的ON、OFF產生。

※ ON：a(常開)接點端子短路，b(常閉)接點端子斷路。

OFF：a(常開)接點端子斷路，b(常閉)接點端子短路。

d. 多段速度與加/減速時間

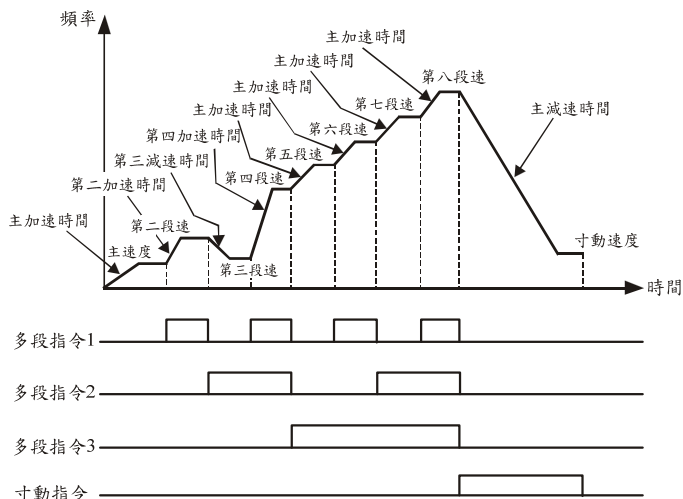

※ 上圖以 8 段速度為範例，第五段速以後的多段速度和寸動速度的加/減速時間，是依照主加/減速時間動作。

※ 在運轉停止時，若寸動指令 ON，則以寸動速度運轉，無需運轉指令。

※ 在多段速度下(主速度除外)，類比輸入端子(Pot、AI)無作用。

※ 加/減速時間請參照設定項次(F2.18~ F2.21)。

【F2.17】 加、減速基準頻率

加/減速時間所對應之頻率，設定範圍：0.01~400.00Hz。

【F2.18/F2.19】 主加速時間/主減速時間

【F2.20~F2.25】 二~四段加速時間/二~四段減速時間

【F2.26/F2.27】 副加速時間/副減速時間

- 多段加/減速時間就是從 0 到達加/減速基準頻率(F2.17)所需的時間，多段指令可同時控制多段速度與多段加/減速時間，設定範圍：0.0~3200.0秒。
- 主速度、第五段速~第十六段速和寸動速度同樣以主加/減速時間為其加/減速時間。
- 副加/減速時間有優先權，副加/減速指令由多機能輸出端子選擇。

5 參數設定說明

說明如下：

副加、減速切換及禁止指令曲線

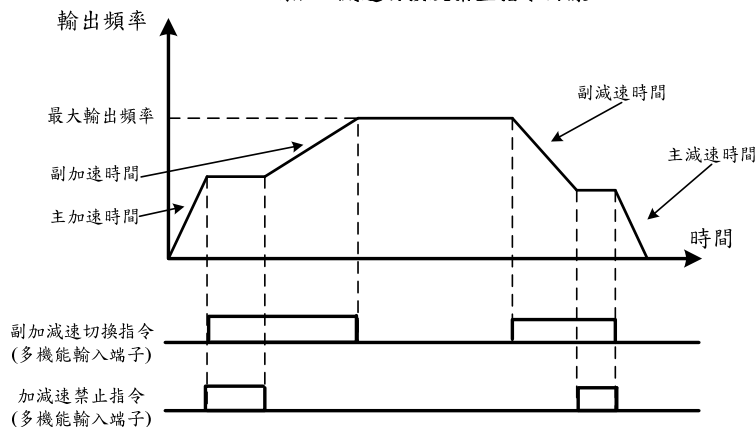

d. 停止指令作用下，加/減速禁止指令無效。

【F2.28】 S字加/減速時間

S字加/減速選擇的主要功能是緩和加/減速時的衝擊。例如：防止輸送線上的物品掉落或緩和電梯升降衝擊。

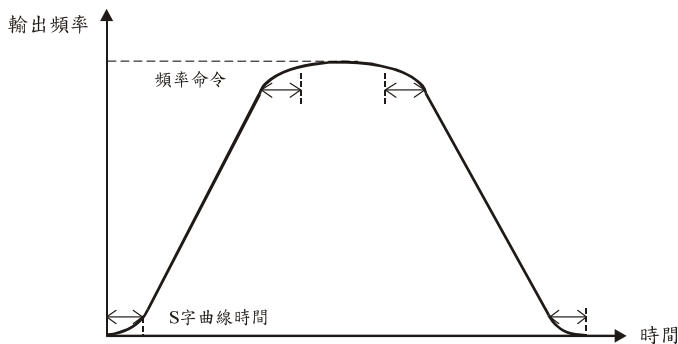

【F2.31】 V/F曲線選擇

a. 設定內容如下：

- 0：直線
- 1：省能源裝置，依負載輕重自動作V/F調整
- 2：2次方曲線
- 3：1.7次方曲線
- 4：1.5次方曲線

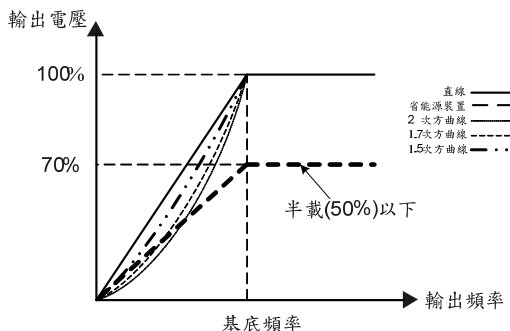

- b. F2.31=1時，當負載電流小時，自動調整變頻器輸出電壓，可以達到節能的效果。
 c. F2.31=2~4時，使用於風扇、幫浦達成省電目的。

【F2.32】 最大輸出頻率

變頻器可操作之最大頻率，設定範圍：0.1~400.0Hz。

【F2.33】 起動頻率

變頻器的起動頻率，設定範圍：0.1~10.0Hz。

【F2.34】 起動電壓

起動頻率之輸出電壓

100V/200V級規格範圍：0.1~50.0V

400V級規格範圍：0.1~100.0V

【F2.35】 基底頻率

馬達基底頻率；依馬達銘牌上標示的頻率設定，設定範圍：0.1~400.0Hz。

【F2.36】 基底電壓

馬達基底電壓；依馬達銘牌上標示的電壓設定。

100V/200V級規格範圍：0.1~255.0V

400V級規格範圍：0.1~510.0V

【F2.37】 第一轉折點頻率

V/F曲線第一轉折點頻率，設定範圍：0.0~399.9Hz。

5 參數設定說明

【F2.38】 第一轉折點電壓

V/F曲線第一轉折點電壓。

100V/200V級規格範圍：0.0~255.0V

400V級規格範圍：0.0~510.0V

【F2.39】 第二轉折點頻率

第二轉折點頻率(參考第F2.37設定說明)

【F2.40】 第二轉折點電壓

第二轉折點電壓(參考第F2.38設定說明)

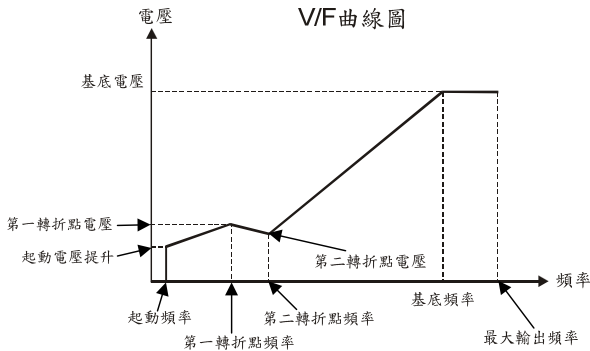

※ 相對關係如下：

- (1) 基底頻率 > 第二轉折點頻率 > 第一轉折點頻率 > 起動頻率。
- (2) 第二轉折點頻率 < 第一轉折點頻率時，第二轉折點無作用。
- (3) 第一、二轉折點頻率 < 起動頻率時，第一、二轉折點無作用。
- (4) F2.34、F2.36、F2.38、F2.40互不限制。

【F2.42】 跳躍頻率1

【F2.44】 跳躍頻率3

為了防止機械共振產生，可利用跳躍頻率方法避開共振頻率，設定範圍：0.0~400.0Hz。

【F2.45】 跳躍頻率區間

共有三組跳躍頻率、一種跳躍頻率區間，設定範圍：0.0~25.5Hz。

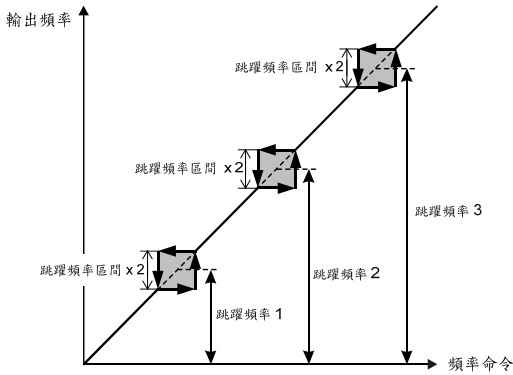

【F2.47】 頻率上限值

輸出頻率的上限值(1.00=最大輸出頻率)，設定範圍：0.00~1.00。

頻率輸出上限 = 頻率上限值(F2.47) × 最大輸出頻率(F2.32)

【F2.48】 頻率下限值

輸出頻率的下限值(1.00=最大輸出頻率)，設定範圍：0.00~1.00。

頻率輸出下限 = 頻率下限值(F2.48) × 最大輸出頻率(F2.32)

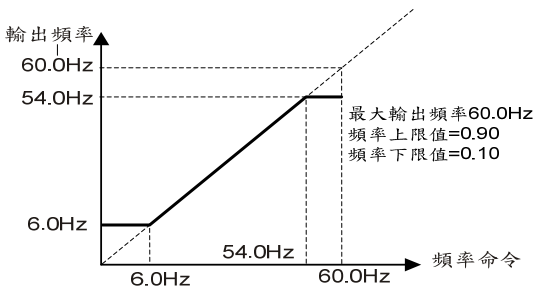

5 參數設定說明

F3 控制參數

【F3.00】 緩行頻率

變頻器加速至緩行頻率下作等速運轉，設定範圍：0.0~400.0Hz。

【F3.01】 緩行時間

變頻器在緩行頻率下等速運轉的時間，設定範圍：0.0~360.0秒。

設定緩行頻率及緩行時間的主要目的是防止馬達滑差現象。馬達滑差發生原因：加速時馬達轉速跟不上而失速及過電流情況。

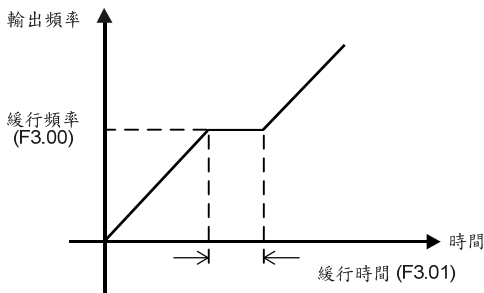

【F3.03】 加速中失速防止準位

加速狀態下，失速防止處理方式為等速運轉 (200%：關閉)，設定範圍：30%~200%之變頻器額定電流。

【F3.04】 等速中失速防止準位

等速狀態下，失速防止處理方式為降速運轉 (200%：關閉)，設定範圍：30%~200%之變頻器額定電流。

【F3.05】 等速中失速防止加速時間設定

等速失速防止時，輸出頻率的加速時間，設定範圍：0.1~3200.0秒。

【F3.06】 等速中失速防止減速時間設定

等速失速防止時，輸出頻率的減速時間，設定範圍：0.1~3200.0秒。

【F3.07】 減速中失速防止選擇

0：減速中失速防止機能無作用。

1：減速中失速防止機能有作用。

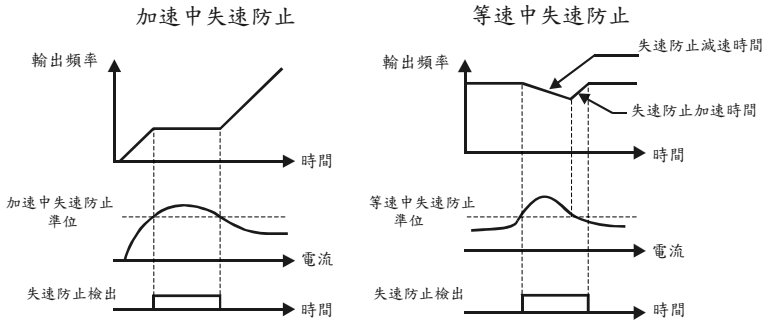

- 選擇有減速中失速防止功能，則減速中失速時，以等速運轉。
- 連接動態煞車裝置時，可視實際需要關閉減速中失速防止功能(F3.07)。
- 若變頻器停機時，主迴路DC bus電壓高於動態煞車電壓準位時，操作面板(或遠端操作器)顯示“Hv”。此時按RUN鍵無法啟動變頻器，若DC bus電壓低於動態煞車電壓準位，則自動恢復正常，回到主畫面。

【F3.09】 馬達滑差補償

- 因馬達會隨負載大小而產生不同的滑差，因此當負載電流大於滑差補償動作準位時，變頻器即補償輸出頻率，以達到恆定轉速，設定範圍：-59.9~60.0Hz。
- 補償頻率 =

$$\frac{\text{負載電流} - (\text{馬達無載電流 (F4.09)})}{\text{馬達額定電流 (F4.08)} - (\text{馬達無載電流 (F4.09)})} \times \text{馬達滑差補償 (F3.09)}$$

【F3.10】 滑差補償之頻率響應時間

- 滑差補償之頻率響應，以5ms為單位。
- 當滑差補償響應太慢時，降低設定值；當滑差補償響應過快導致馬達轉速不穩定時，增加設定值，設定範圍：1~255。

【F3.18】 AVR (自動電壓調變)設定

- 功用：當輸入電源變動時，變頻器自動調整輸出電壓，穩定V/F輸出控制。
- 當AVR設定為0時，參考電壓將為以F0.05電源電壓設定為準。
- 設定範圍：0：無、1：有。

【F3.19】 AVR響應時間

設定AVR電壓調整量的響應時間，設定範圍：0~255ms。

5 參數設定說明

【F3.21】 直流制動能力設定

- 直流制動能力：直流制動時的電流準位。
- 設定範圍：0~150%之變頻器額定電流。

【F3.22】 直流制動反應時間

依直流制動情形增減反應時間，設定範圍：0~255ms。

【F3.23】 啟動時直流制動時間

啟動時直流制動是防止馬達轉向不明之自由運轉，設定範圍：0.0~60.0秒。

【F3.24】 停止時直流制動時間

- 停止時直流制動是防止馬達惰走現象。
- 降速停止時，直流制動時間。設定範圍：0.0~60.0秒。

【F3.25】 停止直流制動頻率

- 直流制動動作頻率點，設定範圍：0.1~60.0Hz。
- 在運轉中，如果改變頻率命令至F2.33(起動頻率)以下時，當輸出頻率降速至啟動頻率以下，則做直流制動，此時F3.25(停止時直流制動頻率)沒有作用。

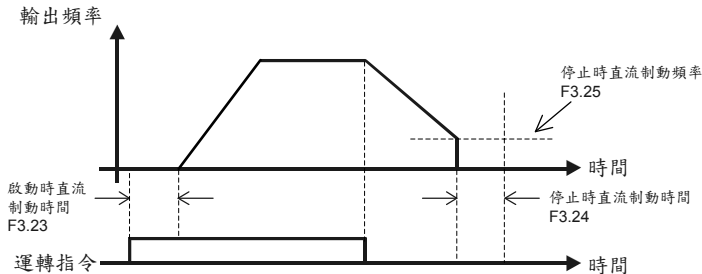

【F3.30】 瞬停復電後再運轉選擇

- 設定內容如下：
 - 0：瞬停復電後不可再起動
 - 1：瞬停復電後可再起動
(參考多機輸出設定之瞬停復電再起動動作中檢出功能)
 - 2：斷電降速停止
 - 3：斷電降速復電後可再起動
- 電源斷電時，不能與發電機同時作啟動，應於發電機啟動完成後再啟動變頻器。
- 斷電降速功能適用於慣性負載，適當調整F3.32~F3.34之設定，使斷電降速過程中馬達產生發電能量，回饋給變頻器，反相對馬達進行減速停止。

【F3.31】 斷電降速電壓準位設定

- 當電源電壓低於F3.31電壓準位時，則降速停止。
- 設定內容如下：

100V級規格範圍75.0~96.0V

200V級規格範圍150.0~192.0V

400V級規格範圍300.0~384.0V

【F3.32】 斷電降速之減算頻率

- a. 斷電降速時，頻率=輸出頻率-減算頻率。
- b. 設定範圍：0.0~20.0Hz。

【F3.33】 斷電降速之減速時間1

輸出頻率大於切換頻率 (F3.35) 的減速時間，設定範圍：0.0~3200.0秒。

【F3.34】 斷電降速之減速時間2

輸出頻率小於切換頻率 (F3.35) 的減速時間，設定範圍：0.0~3200.0秒。

【F3.35】 斷電降速之切換頻率

兩段減速時間 (F3.33和F3.34) 切換之頻率設定值，設定範圍：0.0~400.0Hz。

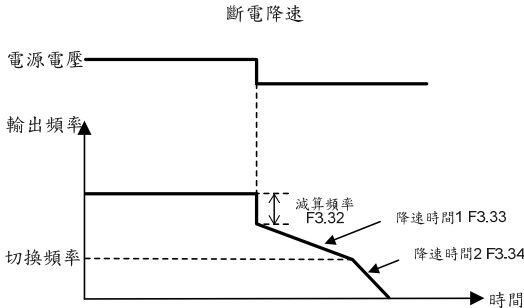

【F3.37】 速度追蹤電流單位

- a. 當電流大於速度追蹤電流時，輸出頻率開始向下搜尋，設定範圍：0~200%之變頻器額定電流。
- b. 速度追蹤的功能，主要是應用在瞬間停電復電後再運轉的速度尋找、異常再啟動的速度尋找，或由輸入端子下達速度尋找指令時的動作。
- c. 可參考多機能輸入端子設定F5.19~F5.22的速度尋找功能。

【F3.38】 速度追蹤前之遮斷時間

速度追蹤前之遮斷輸出時間，設定範圍：0.1~60.0秒。應用範例請參考第88頁之多機能輸入端子X1~X4設定，±11：由最大頻率作速度尋找及±12：由頻率命令作速度尋找之圖示說明。

【F3.39】 速度追蹤的V/F

速度追蹤動作中以所設定的V/F百分比電壓輸出，設定範圍：0~100%。

5 參數設定說明

F4 保護參數

【F4.07】 馬達過載保護選擇

a. 過載保護選擇的設定內容如下：

- 0：馬達過載保護無效，
- 1：馬達過載保護有效(考慮馬達運轉頻率作OL保護)。
- 2：獨立散熱風扇馬達過載保護有效(不考慮馬達運轉頻率作OL保護)。

b. 防止馬達長期操作於過載狀態而產生損壞，若關閉馬達過載保護，可能使馬達損壞。

【F4.08】 馬達額定電流

馬達額定電流：依馬達銘牌上標示設定，設定範圍：10~150%變頻器額定電流；設定單位：安培。

【F4.09】 馬達無載電流

馬達無載電流：約為馬達額定電流之三分之一，可設定範圍：0~馬達額定電流值；設定單位：安培。

【F4.10】 馬達過載跳脫時間

- a. 運轉電流超過馬達額定電流F4.08時，進入反限時曲線OL保護計時階段。
- b. 當輸出電流達F4.08馬達額定電流150% 連續運轉F4.10之設定時間，跳OL保護。
- c. 馬達過載保護(OL)保護的動作時間，設定範圍：0.5~10.0分鐘。

【F4.12】 變頻器過熱跳脫保護準位

變頻器溫度達跳脫準位，則跳OH保護，設定範圍：85~115℃。

【F4.13】 變頻器過熱警示選擇

a. 設定內容如下：

- 0：無，關閉過熱警示偵測。
- 1：過熱警示(OHt)，變頻器持續運轉(relay 檢出)。
- 2：過熱警示(OHt)，變頻器將降低載波運轉，每5分鐘降一級載波(relay 檢出)。
- 3：過熱警示(OHt)，跳 OHt 時變頻器強迫停止運轉，並且起動風扇；待溫度降至溫度遲滯區間以下才繼續運轉(relay 檢出)。

b. relay 檢出，請參考設定項次F5.26多機能輸出端子設定。

【F4.14】 變頻器過熱警示準位

設定變頻器的過熱警示(OHt)準位；當風扇損壞前或變頻器之散熱片有棉絮或異物時溫度會升高，可作預先保養維修提醒；設定範圍：45~105℃。

【F4.15】 變頻器溫度遲滯區間

當溫度升高至警示準位時作警示檢出，並顯示"OHt"，等到溫度降至溫度遲滯區間以下才關閉警示檢出；設定範圍：0.1~10℃。

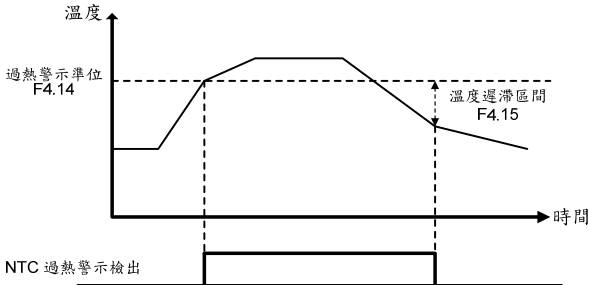

【F4.17】 風扇控制選擇

a. 功能：延長風扇壽命、節省能源消耗、延長散熱片清潔週期。

b. 設定內容如下：

0：強制風冷

變頻器送電後，風扇持續運轉不停止。

1：運轉風冷：

當變頻器啟動時風扇才運轉；當變頻器停止時，需等待(F4.19)最小動作時間後，風扇才停止。

2：溫控風冷：

當變頻器溫度高於(F4.18)風扇動作溫度時，風扇才運轉；當變頻器溫度降至(F4.15)溫度遲滯區間以下，並再等(F4.19)最小動作時間後，風扇才停止。

【F4.18】 風扇動作溫度

風扇起動的溫度準位，設定範圍：25~60℃。

【F4.19】 風扇最小動作時間

設定風扇強迫運轉最小動作時間後，再依(F4.17)風扇控制選擇設定風扇運轉控制方式；設定範圍：0.1~25min。

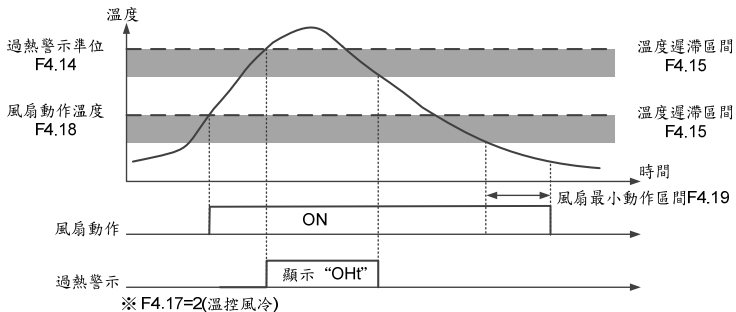

5 參數設定說明

【F4.25】系統過負載檢出設定(OLO)

a. 設定內容如下：

- 0：無過負載檢出。
- 1：有過負載檢出。

b. 過負載檢出的目的是防止系統受到損壞，所以檢出準位 (F4.28) 與檢出時間 (F4.29) 可依照使用者需求設定。

【F4.26】系統過負載檢出狀態

設定內容如下：

- 0：頻率等速才檢出。
- 1：運轉中檢出：變頻器啟動後運轉中檢出。

【F4.27】系統過負載後輸出設定

設定內容如下：

- 0：檢出過負載後可繼續運轉。
- 1：檢出過負載後異常跳脫。

【F4.28】系統過負載檢出準位

過負載檢出功能之電流準位，設定範圍：30~200%變頻器額定電流。

【F4.29】系統過負載檢出時間

a. 過負載檢出如下圖

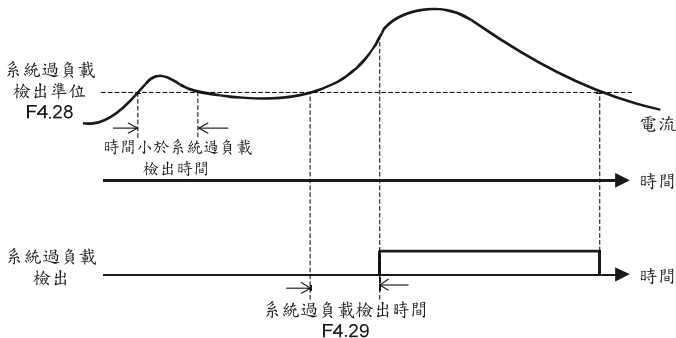

b. 過負載持續發生須超過過負載檢出時間才會檢出，並且操作面板顯示"OLO"。

c. 設定範圍：0.1~300.0秒。

F5 多機能參數

【F5.00】類比輸入Pot選擇

設定內容如下：

- 0：類比輸入增益
- 1：頻率命令
- 2：電流限制
- 3：V/F獨立調整之V

【F5.01】類比輸入AI選擇

設定內容如下：

- 0：類比輸入增益
- 1：頻率命令
- 2：電流限制
- 3：V/F獨立調整之V
- 4：PTC溫度
- 5：PID回授

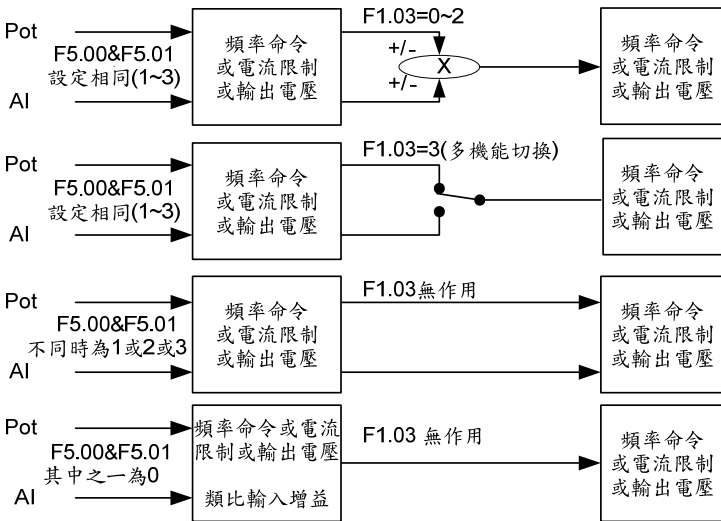

※ 當F1.01 = 0，頻率命令由類比信號輸入，則F5.00與F5.01至少有一個必須設定為1，否則頻率命令為0.0Hz。

※ F5.00與F5.01設定相同(1~3)時，F1.03設定0~2才有作用。

※ F5.00(F5.01)設為0時，須與F5.00(F5.01)設定為1~3搭配使用，作為增益調整。

5 參數設定說明

【F5.03】 類比輸入Pot增益比

類比輸入Pot增益比調整，設定範圍：0.00~2.00。

【F5.04】 類比輸入Pot偏壓比

類比輸入Pot偏壓比調整，設定範圍：-1.00~1.00。

【F5.05】 類比輸入AI增益比

類比輸入AI增益比調整，設定範圍：0.00~2.00。

【F5.06】 類比輸入AI偏壓比

類比輸入AI偏壓比調整，設定範圍：-1.00~1.00。

a. 類比輸入為

Pot (面板設定旋鈕)

AI (類比輸入端子)：4~20mA(2~10V)或0~20mA(0~10V)

b. 最大頻率命令值=最大輸出頻率(F2.32) × 類比輸入增益比(F5.03或F5.05)

c. 偏壓比對應的頻率(C.V)=

最大輸出頻率(F2.32) × 類比輸入偏壓比(F5.04或F5.06)

d. 頻率命令：

$$\text{頻率命令} = \frac{(\text{最大頻率命令} - \text{C.V})}{10\text{V (或 } 20\text{mA})} \times (\text{類比命令}) + \text{C.V}$$

*C.V = 偏壓比對應的頻率

例如：假設類比輸入偏壓比=0.00

最大輸出頻率60.0Hz

類比輸入增益比=1.20

最大輸出頻率60.0Hz

類比輸入增益比=0.80

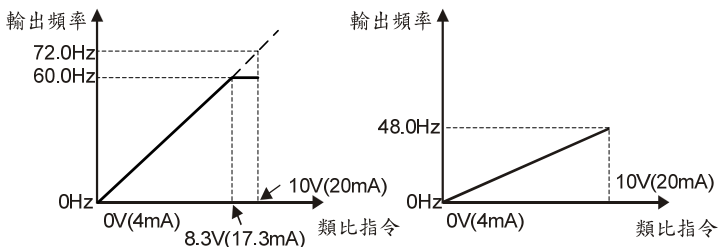

例如：假設類比輸入增益比=1.00

最大輸出頻率60.0Hz

類比輸入偏壓比=0.05

最大輸出頻率60.0Hz

類比輸入偏壓比=-0.05

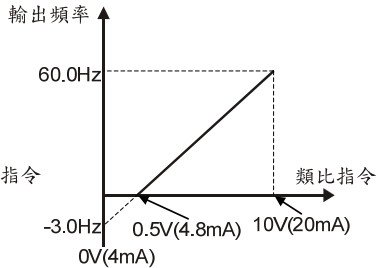
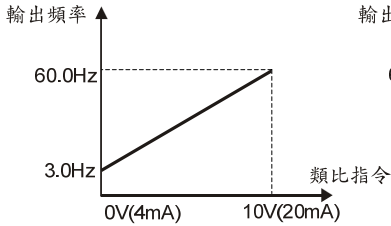

例如：逆向控制應用範例

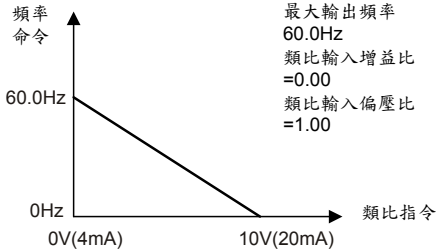

最大輸出頻率

60.0Hz

類比輸入增益比

=0.00

類比輸入偏壓比

=1.00

【F5.07】類比頻率濾波設定

- a. 當Pot或AI設定為頻率命令控制時(F1.01=0)，作信號濾波。
- b. 設定值越大，反應越慢，當設定值為0時則無濾波，設定範圍：0~255。

5 參數設定說明

【F5.19】 端子X1多機能輸入設定

【F5.21】 端子X3多機能輸入設定

a. '+'代表a接點(常閉接點)

'-'代表b接點(常閉接點)

b. 多機能端子X1~X3可設定為以下功能之任一種：

±1：寸動指令(參考多段速度 F2.16 說明)

±2：副加，減速指令切換(參考多段加/減速時間 F2.26 和 F2.27 說明)

±3：多段指令1(參考多段速度 F2.00 ~ F2.07 說明)

±4：多段指令2(參考多段速度 F2.00 ~ F2.07 說明)

±5：多段指令3(參考多段速度 F2.00 ~ F2.07 說明)

±7：重置指令

變頻器異常跳脫時，可由重置指令來解除異常狀態。

±8：外部異常指令(EF)

運轉時，可接受外部異常訊息使變頻器跳脫，停止時，無作用。

±9：遮斷輸出指令(bb)

可遮斷變頻器輸出電壓。

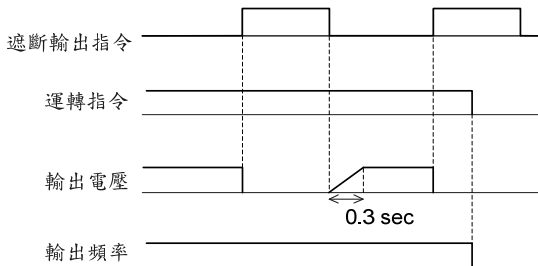

±10：自然停止指令(Fr)

可使變頻器與馬達瞬間脫離。

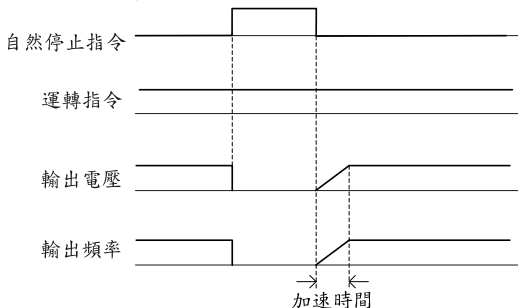

±11：由最大頻率作速度尋找

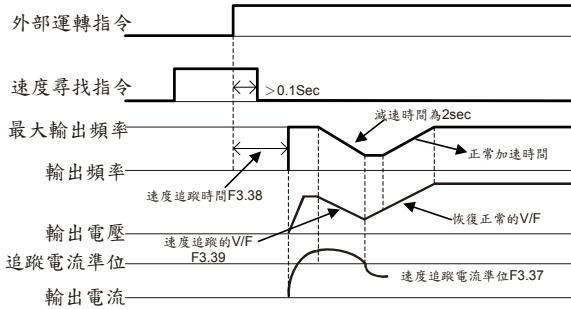

±12：由頻率命令作速度尋找

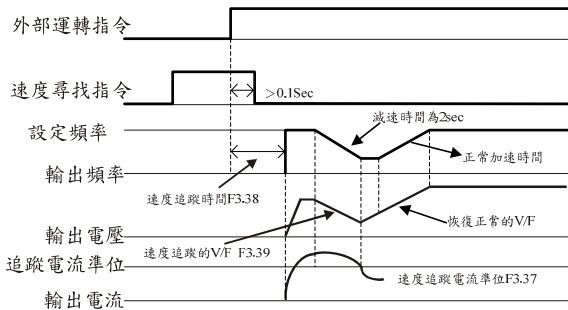

±13：加/減速禁止指令(參考多段加/減速時間)

±14：UP指令

頻率命令遞增

±15：DOWN指令

頻率命令遞減

±16：UP/DOWN頻率命令清除

頻率命令被清除為0.00Hz

±17：UP/DOWN 頻率命令確認

(1) 若多機能輸入端子 X1~X4 選擇此功能時，則 UP/DOWN 頻率命令經確認後，才會生效。

多機能端子開路：UP/DOWN 指令調整頻率命令值，輸出頻率不隨頻率命令改變。

多機能端子短路：輸出頻率開始加/減速至頻率命令值。

(2) 若多機能輸入端子 X1~X4 不選擇此功能，則只要 UP/DOWN 指令動作，UP/DOWN 頻率命令立即生效。

5 參數設定說明

±18：選擇類比輸入源(Pot/AI)

項次 F1.03 類比輸入源選擇=3(Pot 或 AI) 時

設定18時	a接點時，選擇類比輸入源為Pot端子輸入。
	b接點時，選擇類比輸入源為AI端子輸入。
設定-18時	a接點時，選擇類比輸入源為AI端子輸入。
	b接點時，選擇類比輸入源為Pot端子輸入。

±19：主副頻率命令選擇

設定19時	a接點時，頻率命令為主頻率命令。(F1.01)
	b接點時，頻率命令為副頻率命令。(F1.02)
設定-19時	a接點時，頻率命令為副頻率命令。(F1.02)
	b接點時，頻率命令為主頻率命令。(F1.01)

±20：程序運轉起動指令輸入

當 F6.00 項次設定值不為零(使用程序運轉)，程序運轉起動指令 ON 時，變頻器的輸出頻率依程序運轉項次的設定自動運轉。若程序運轉起動指令 OFF 時，則程序運轉終止。

±21：程序運轉暫停指令輸入

運轉中可利用程序運轉暫停指令暫時中斷運轉的程序，待暫停指令取消後，接續運轉程序繼續運轉。

±22：正轉

使用方式，請參考 F1.00 項次說明。

±23：反轉

使用方式，請參考 F1.00 項次說明。

±24：三線自保持啟動/停止指令

F1.00=0
F5.19=22
F5.20=23
F5.21=24

F1.00=1
F5.19=22
F5.20=23
F5.21=24

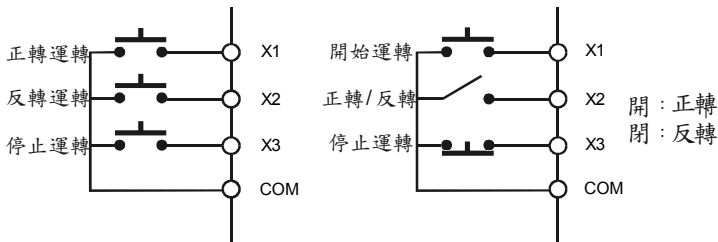

±25：直流制動允許(停止時)

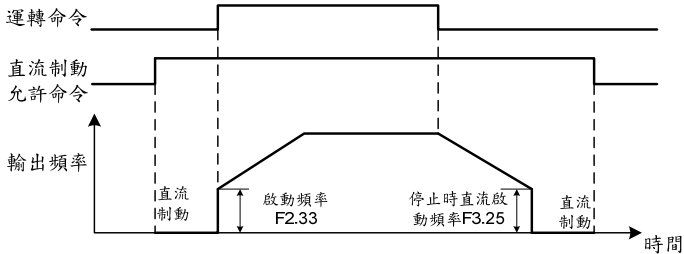

- (1) 變頻器靜止時，當直流制動允許命令 ON 時，直流制動形成。
- (2) 直流制動動作時，輸出電流依照 F3.21 設定值。
- (3) 假設運轉命令或者寸動命令成立時，直流制動會被清除，馬達開始運轉至頻率命令。
- (4) 若運轉命令或者寸動命令消失，輸出頻率降至停止時直流制動頻率點 (F3.25)，則直流制動形成。

±26：計數輸入

- (1) 多機能輸入端子，可利用外部觸發信號使變頻器計數。
- (2) 選用 4V 以上，13V 以下的輸入界面信號。
- (3) 觸發信號：如近接開關、光電檢知器的信號。

±27：計數清除

清除計數器的值

±28：電流限制允許

- (1) 多機能11輸入動作且F5.00、F5.01其中一項設為2。
 - a. 電流限制允許。
 - b. 監看模式下監看(範圍為1~150)。
- (2) 多機能輸入未動作
 - a. 電流限制允許無作用。
 - b. 監看模式下監看，此時的值與F3.04相同(範圍為30~200)。

【F5.25】 數位入力反應時間

- a. 設定多機能端子(X1~X3)端子之入力反應時間(數位debouncing)。
- b. 當輸入信號長度小於設定時間，則軟體不接受和不處理此輸入信號。

【F5.26】 端子Y1多機能輸出設定

- a. Y1為NPN連動型輸出端子，
- b. '+'代表a接點(常開接點)，
'-'代表b接點(常閉接點)。

5 參數設定說明

c. Y1輸出端子可設定為以下功能之任一種：

- ±1：運轉中檢出
變頻器運轉命令下即檢出。
- ±2：等速檢出
等速運轉時即檢出。
- ±3：零速中檢出
變頻器無輸出時檢出，DC 制動時不檢出。
- ±4：頻率偵測

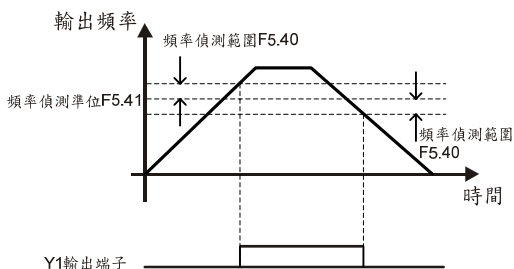

±5：系統過負載檢出(OLO)

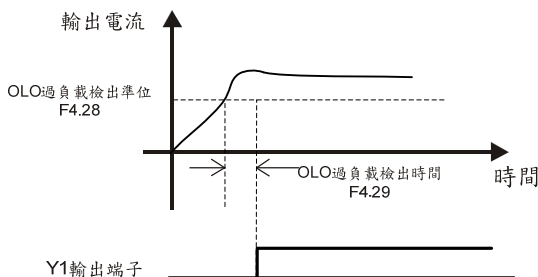

±6：失速防止檢出

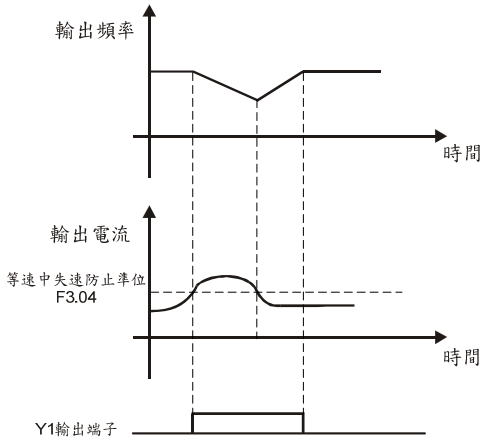

±7：低電壓檢出(LE)

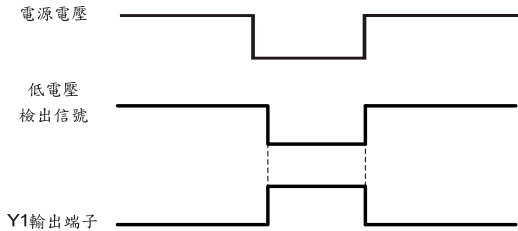

±8：煞車晶體動作檢出(db)

變頻器DC bus電壓大於動態煞車電壓準位時檢出。

5 參數設定說明

- ±9：瞬停復電再起動動作中檢出
F3.30設定為1時，才有動作。

瞬停復電再起動動作中檢出功能

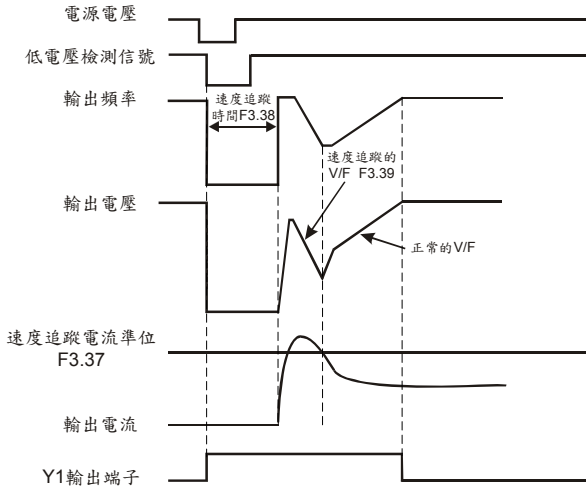

- ±10：異常再起動動作中檢出

異常再起動動作中檢出功能

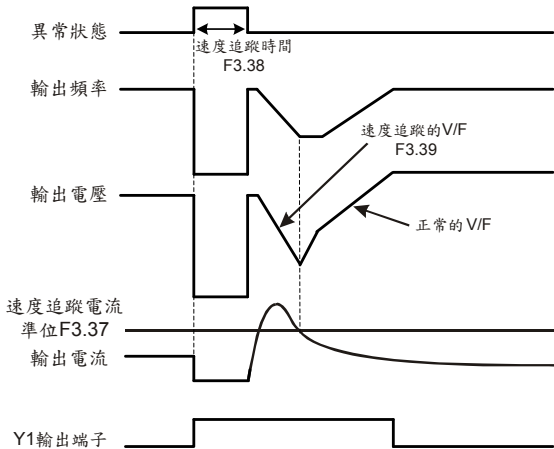

±11：異常信號檢出

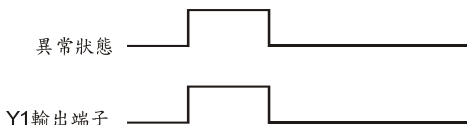

±12：程序運轉檢出

執行程序運轉時檢出。

±13：程序運轉一階段運轉完成檢出

程序運轉，每完成一個運轉程序，Y1(TA/TC)輸出端子檢出，輸出信號維持0.1秒。

±14：程序運轉一週期運轉完成檢出

程序運轉，所有運轉程序皆完成，Y1(TA/TC)輸出端子檢出，輸出信號維持0.1秒。

±15：程序運轉暫停檢出

程序運轉中，程序運轉暫停指令動作時檢出。

±16：計數值到達檢出1

計數值等於F5.36設定時檢出1

±17：計數值到達檢出2

計數值等於F5.37設定時檢出2

±18：反轉檢出

變頻器運轉為反轉時，則Y1(TA/TC)輸出端子檢出。

±19：變頻器過熱警示檢出(OHt)

當溫度檢知器(NTC)檢知變頻器溫度高於(F4.14)警示準位時，則Y1(TA/TC)輸出端子檢出。

±20：風扇運轉檢出

±21：外接PTC溫度警示檢出(OH1)

當外接PTC檢知器檢知溫度高於(F4.21)警示準位時，則Y1(TA/TC)輸出端子檢出。

【F5.30】 UP/DOWN控制記憶選擇

0：斷電清除記憶：斷電會將頻率命令清除為 0.00Hz。

1：斷電記憶：復電後頻率命令為斷電前所記憶的值，記憶在 F5.30。

5 參數設定說明

【F5.31】 UP/DOWN微調頻率

UP/DOWN 指令每次動作，頻率命令改變值之間距

設定值	單位	頻率命令改變值之間距
0 :	0.01Hz	0.01Hz
1~8 :	$\times 0.05\text{Hz}$	設定8表示頻率命令改變值($8 \times 0.05\text{Hz} = 0.4\text{Hz}$)
9 :	0.5Hz	0.5Hz
10~250 :	$\times 0.1\text{Hz}$	設定250表示頻率命令改變值($250 \times 0.1\text{Hz} = 25\text{Hz}$)

【F5.32】 UP/DOWN微調時間

1~5：端子微調反應時間(超過設定值即連續加/減速 單位:秒)：

端子UP/DOWN設定ON/OFF超過設定時間時，連續加(減)速到最大(零速度)輸出頻率-ON代表加速設定和OFF代表減速設定。

6：邊緣觸發：

不受微調反應時間控制，以輸入信號做邊緣觸發動作，信號反應時間為30ms。

【F5.33】 UP/DOWN頻率命令調整

直接以KEYPAD調整頻率，為頻率命令設定值；UP/DOWN指令改變頻率命令值，數值改變後5秒回存至F5.33項次。

UP/DOWN指令時序圖：

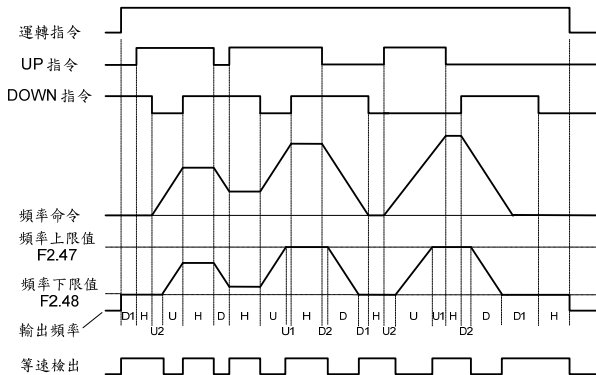

U=UP (加速)狀態

D=DOWN (減速)狀態

H=HOLD (等速)狀態

U1=UP狀態，被限制在頻率上限值

U2=UP狀態，被限制在頻率下限值

D1=DOWN狀態，被限制在頻率下限值

D2=DOWN狀態，被限制在頻率上限值

【F5.35】 計數值模式

設定內容如下：

- 0：上數模式
- 1：下數模式

【F5.36】 計數值到達設定 1

計數值到達設定 1：0~9999 次。(計數值到達檢出 1 請參考 F5.26)

【F5.37】 計數值到達設定 2

計數值到達設定 2：0~9999 次。(計數值到達檢出 2 請參考 F5.26)

上數模式：

F5.35=0
F5.36=500
F5.37=400

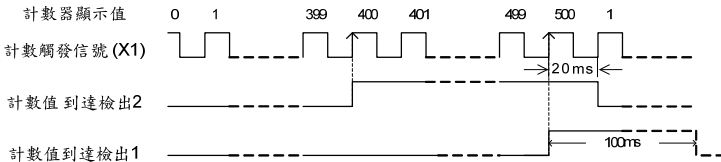

下數模式：

F5.35=1
F5.36=1000
F5.37=2000

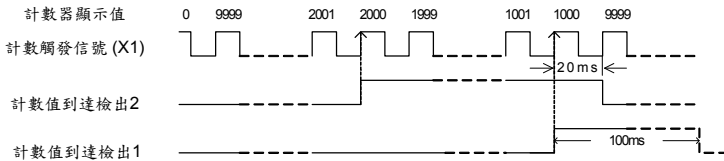

※ 觸發信號的週期不得低於20ms (<50Hz)

※ 多機能Y1(TA/TC)輸出端子檢出信號至少維持100ms

【F5.39】 等速檢出範圍

設定範圍：0.0~10.0Hz，參考多機能Y1(TA/TC)輸出端子設定F5.26之等速中檢出。

【F5.40】 頻率偵測範圍

設定範圍：0.0~10.0Hz，參考多機能Y1(TA/TC)輸出端子設定F5.26之頻率偵測。

【F5.41】 頻率偵測單位

設定範圍：0.0~400.0Hz，參考多機能Y1(TA/TC)輸出端子設定F5.26之頻率偵測。

5 參數設定說明

F6 特殊參數

【F6.55】 通訊位址

- a. 使用RS-485介面來監控變頻器時，每一台變頻器必須設定通訊位址；且通訊位址不可重複；設定範圍：0~254，最多可串聯31部。
- b. 00—無作用，不作通訊溝通。

【F6.56】 通訊傳輸速率

設定通訊的傳輸速率(bps：位元／秒)；請選擇與上層機器相同的速率。

- 0：4800bps
- 1：9600bps
- 2：19200bps

【F6.57】 通訊格式

- a. 串列通訊為非同步串列傳輸，1 frame = 11 位元；格式共分三種：[8,N,2 for RTU]：1 start 位元，8 data 位元，2 stop 位元。
[8,E,1 for RTU]：1 start 位元，8 data 位元，1 偶同位，1 stop 位元。
[8,O,1 for RTU]：1 start 位元，8 data 位元，1 奇同位，1 stop 位元。
- b. 請參考 6-3 通訊格式。

【F6.58】 通訊逾時設定(Cot)

- a. 設定通訊逾時的檢出時間。
- b. 當使用 Modbus 通訊時，在設定時間內無任何資料傳輸時，即表示通訊逾時，則數位面板上將顯示“Cot”。
- c. 設定內容如下：
0.0：無逾時檢出
0.1~100.0：逾時檢出時間設定

【F6.59】 通訊逾時處理

設定通訊逾時的時候，驅動器的處置狀態。 0：警告並繼續運轉

- 1：警告並減速停止
- 2：警告並自由運轉停止

※ 停止後需重新下運轉指令

※ 逾時檢出後，恢復通訊後則警告顯示自動消失。

【F6.60】 多機能輸入控制選擇

設定內容如下：

- 0：多機能輸入由多機能端子控制
- 1：多機能輸入由通訊控制

6 通訊說明

6-1 Modbus通訊埠 (RJ-45)接線說明



端子種類	端子腳位	端子名稱	說明
Modbus(RS-485) 通訊	1	通訊傳輸端子(DX+)	RS-485 差動輸入 (註 1)
	2	通訊傳輸端子(DX-)	Modbus(RS-485)通訊僅使用 1,2 腳位
	3-8	保留	保留

註 1：終端電阻 100Ω 選擇由 DSW1 切換 (出廠值：ON)

註 2：當多台使用時必須將各台 DX+、DX- 相同端子併接起來，並將隔離網覆線接至 FG。

註 3：終端電阻開關之功用為終止電氣信號，以免產生反射信號而干擾正常信號傳遞，多台使用時需將第一台和最後一台 DSW1 (終端電阻開關) 必須切至上方(ON)，其餘各台 DSW1 皆切至下方，出廠設定為 DSW1 切至上方。

註 4：從主機 (PC, PLC) 到最後一台的線距不得超過 500m。

註 5：最多控制到 31 台。

6 通訊說明

6-2 通訊參數設定

- F6.55 通訊位址：00~254 (00—通訊功能關閉)
- F6.56 通訊傳輸速率：
 - 0：4800bps
 - 1：9600bps
 - 2：19200bps
- F6.57 通訊格式：
 - 0：8,N,2 for RTU
 - 1：8,E,1 for RTU
 - 2：8,O,1 for RTU
- F6.58 通訊逾時設定：
 - 0.0：無逾時檢出
 - 0.1~100.0sec：逾時檢出時間設定
- F6.59 通訊逾時處理：
 - 0：警告並繼續運轉
 - 1：警告並減速停止
 - 2：警告並自由運轉停止
- F6.60 多機能輸入控制選擇：
 - 0：多機能輸入由多機能端子控制
 - 1：多機能輸入由通訊控制

6-3 通訊格式

串列通訊為非同步串列傳輸，1 frame = 11 位元；格式分為以下三種型式：

- 8,N,2：1 start 位元，8 data 位元，2 stop 位元

START	BIT0	BIT1	BIT2	BIT3	BIT4	BIT5	BIT6	BIT7	STOP	STOP
-------	------	------	------	------	------	------	------	------	------	------

- 8,E,1：1 start 位元，8 data 位元，1 偶同位，1 stop 位元

START	BIT0	BIT1	BIT2	BIT3	BIT4	BIT5	BIT6	BIT7	EVEN PARITY	STOP
-------	------	------	------	------	------	------	------	------	----------------	------

- 8,O,1：1 start 位元，8 data 位元，1 奇同位，1 stop 位元

START	BIT0	BIT1	BIT2	BIT3	BIT4	BIT5	BIT6	BIT7	ODD PARITY	STOP
-------	------	------	------	------	------	------	------	------	---------------	------

6-4 訊息格式

位址	功能碼	資料 n	...	資料 1	資料 0	CRC 0	CRC 1	END
通訊位址 (1 byte)	訊息指令 (1 Byte)	訊息資料 (資料長度“n”：視功能碼而定)				CRC 檢查碼		無傳輸時間 ≥10ms

●位址：

- 00H—主機對所有副機作廣播，副機接受指令後並不作回傳。
- 01H~FEH—主機對所指定的副機下指令。

●功能碼：

- 03H—讀取多個暫存器。
- 06H—寫入單一暫存器。
- 08H—副機偵測。
- 10H—寫入多個暫存器。

●資料：包含啟始暫存器，暫存器個數，資料長度(最大 8 筆)，資料內容(最大 16 位元組)。註：資料長度—1 byte，其他—1 word (2 bytes)。

●檢查碼 CRC：(Cyclical Redundance Check) 將訊息內所有位元組作 16-bit CRC 運算所得的檢查碼。

●訊息長度：訊息長度介於上表的最大與最小值之間，03H 與 10H 長度依暫存器個數而定。(請參照功能碼說明)

功能碼	說明	命令訊息		回傳訊息	
		最小 (bytes)	最大 (bytes)	最小 (bytes)	最大 (bytes)
03H	讀取多個暫存器	8	8	7	21
06H	寫入單一暫存器	8	8	8	8
08H	驅動器偵測	8	8	8	8
10H	寫入多個暫存器	11	25	8	8

6 通訊說明

●功能碼說明：

※03H (讀取多個暫存器):

命令訊息

通訊位址	功能碼	啟始暫存器		暫存器個數		CRC 檢查碼	
		高位元	低位元	高位元	低位元	低位元	高位元
02H	03H	21H	01H	00H	02H	9FH	C4H

此範例是主機讀取 02 副機的 2 個暫存器資料：從(2101H-啟始暫存器)起至(2102H-暫存器個數)為止共 2 個暫存器。

回傳訊息

通訊位址	功能碼	資料個數 (BYTES)	2101H 資料		2102H 資料		CRC 檢查碼	
			高位元	低位元	高位元	低位元	低位元	高位元
02H	03H	04H	55H	00H	17H	70H	D6H	EBH

副機接收完後，則回傳 4 bytes 資料，分別為 2101H=5500H，2102H=1770H。

注意：主機不可以同步廣播 03H 指令，否則副機將不予理會。

※06H (寫入單一暫存器)：

命令訊息

通訊位址	功能碼	暫存器位址		暫存器資料		CRC 檢查碼	
		高位元	低位元	高位元	低位元	低位元	高位元
02H	06H	20H	01H	17H	70H	DDH	EDH

此範例是主機將資料 1770H 寫入 02 副機的暫存器 2001H 之中。

回傳訊息

通訊位址	功能碼	暫存器位址		暫存器資料		CRC 檢查碼	
		高位元	低位元	高位元	低位元	低位元	高位元
02H	06H	20H	01H	17H	70H	DDH	EDH

副機接收完後將資料寫入暫存器，並將原本接收的訊息回傳給主機。主機可用 06H 功能碼同步廣播予所有的副機，但不回傳。

※08H (副機偵測): 僅可以在通訊測試時使用

命令訊息

通訊位址	功能碼	資料 1		資料 2		CRC 檢查碼	
		高位元	低位元	高位元	低位元	低位元	高位元
02H	08H	00H	00H	AAH	55H	5EH	A7H

此範例是主機用 08H 功能碼診斷偵測 02 副機資料：0000H 和 AA55H。

回傳訊息

通訊位址	功能碼	資料 1		資料 2		CRC 檢查碼	
		高位元	低位元	高位元	低位元	低位元	高位元
02H	08H	00H	00H	AAH	55H	5EH	A7H

副機確實收到訊息後，回傳相同的訊息；資料 1 必須為 0000H，資料 2 可為任意值。
注意：主機不可以同步廣播 08H 指令，否則副機將不予理會。

※10H (寫入多個暫存器):

命令訊息

通訊位址	功能碼	啟始暫存器		暫存器個數		資料個數	第一筆資料		第二筆資料		CRC 檢查碼	
		高位元	低位元	高位元	低位元		低位元	低位元	高位元	低位元	高位元	
02H	10H	20H	00H	00H	02H	04H	10H	11H	17H	70H	3FH	FBH

此範例是主機將兩筆資料(1011H、1770H)共 4bytes 寫入 02H 副機暫存器的 2000H 及 2001H。

回傳訊息

通訊位址	功能碼	啟始暫存器		暫存器個數		CRC 檢查碼	
		高位元	低位元	高位元	低位元	低位元	高位元
02H	10H	20H	00H	00H	02H	4AH	3BH

副機接收完資料後將寫入暫存器，並回傳 4 bytes 資料，分別為 2000H 和 2001H。主機可用同步廣播的方式，將多筆資料寫入多個暫存器，以達成同步更改資料。

6 通訊說明

6-5 CRC 檢查碼運算方法

下列為產生 CRC 檢查碼的運算流程圖：

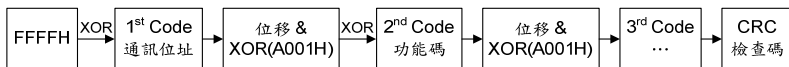

以下例子是說明如何產生 CRC 檢查碼。

範例：透過通訊位址 02H 和功能碼 03H，用 CRC-16 運算法產生 CRC 檢查碼 D140。

	1 1 1 1 1 1 1 1 1 1 1 1 1 1 1 1	
First Code 02H	0 0 0 0 0 0 1 0	XOR
	1 1 1 1 1 1 1 1 1 1 1 1 1 1 0 1	
MOVE 1	0 1 1 1 1 1 1 1 1 1 1 1 1 1 1 0 1	
	1 0 1 0 0 0 0 0 0 0 0 0 0 0 0 1	
	1 1 0 1 1 1 1 1 1 1 1 1 1 1 1 1	
MOVE 2	0 1 1 0 1 1 1 1 1 1 1 1 1 1 1 1 1	
	1 0 1 0 0 0 0 0 0 0 0 0 0 0 0 1	
	1 1 0 0 1 1 1 1 1 1 1 1 1 1 1 0	
MOVE 3	0 1 1 0 0 1 1 1 1 1 1 1 1 1 1 1 0	
MOVE 4	0 0 1 1 0 0 1 1 1 1 1 1 1 1 1 1 1	
	1 0 1 0 0 0 0 0 0 0 0 0 0 0 0 1	
	1 0 0 1 0 0 1 1 1 1 1 1 1 1 1 0	
MOVE 5	0 1 0 0 1 0 0 1 1 1 1 1 1 1 1 1 0	
MOVE 6	0 0 1 0 0 1 0 0 1 1 1 1 1 1 1 1 1	
	1 0 1 0 0 0 0 0 0 0 0 0 0 0 0 1	
	1 0 0 0 0 1 0 0 1 1 1 1 1 1 1 0	
MOVE 7	0 1 0 0 0 0 1 0 0 1 1 1 1 1 1 1 0	
MOVE 8	0 0 1 0 0 0 0 1 0 0 1 1 1 1 1 1 1	
	1 0 1 0 0 0 0 0 0 0 0 0 0 0 0 1	
	1 0 0 0 0 0 0 0 1 0 0 1 1 1 1 0	
Second Code 03H	0 0 0 0 0 0 1 1	
	1 0 0 0 0 0 0 1 0 0 1 1 1 1 0 1	
MOVE 1	0 1 0 0 0 0 0 0 1 0 0 1 1 1 1 0 1	
	1 0 1 0 0 0 0 0 0 0 0 0 0 0 0 1	
	1 1 1 0 0 0 0 0 1 0 0 1 1 1 1 1	
MOVE 2	0 1 1 1 0 0 0 0 0 1 0 0 1 1 1 1 1	
	1 0 1 0 0 0 0 0 0 0 0 0 0 0 0 1	
	1 1 0 1 0 0 0 0 0 1 0 0 1 1 1 0	
MOVE 3	0 1 1 0 1 0 0 0 0 0 1 0 0 1 1 1 0	
MOVE 4	0 0 1 1 0 1 0 0 0 0 0 1 0 0 1 1 1	
	1 0 1 0 0 0 0 0 0 0 0 0 0 0 0 1	
	1 0 0 1 0 1 0 0 0 0 0 1 0 0 1 0	
MOVE 5	0 1 0 0 1 0 1 0 0 0 0 0 1 0 0 1 0	
MOVE 6	0 0 1 0 0 1 0 1 0 0 0 0 0 1 0 0 1	
	1 0 1 0 0 0 0 0 0 0 0 0 0 0 0 1	
	1 0 0 0 0 1 0 1 0 0 0 0 0 1 0 1	
MOVE 7	0 1 0 0 0 0 1 0 1 0 0 0 0 0 1 0 1	
	1 0 1 0 0 0 0 0 0 0 0 0 0 0 0 1	
	1 1 1 0 0 0 1 0 1 0 0 0 0 0 1 1	
MOVE 8	0 1 1 1 0 0 0 1 0 1 0 0 0 0 0 1 1	
	1 0 1 0 0 0 0 0 0 0 0 0 0 0 0 1	
	1 1 0 1 0 0 0 1 0 1 0 0 0 0 0 0	
CRC :	D 1 4 0	

以下為使用 C 語言所寫的 CRC 檢查碼範例程式：

```

unsigned char *data;           //通訊訊息指標
unsigned char length;         //通訊訊息長度
unsigned int crc_chk(unsigned char *data,unsigned char length)
{
    int i;
    unsigned int reg_crc=0xffff;
    while(length--)
    {
        reg_crc^=*data++;
        for(i=0;i<8;i++)
            if(reg_crc&0x01)
                reg_crc=(reg_crc>>1)^0xa001;
            else
                reg_crc=reg_crc>>1;
    }
}

```

6-6 傳輸處理時間

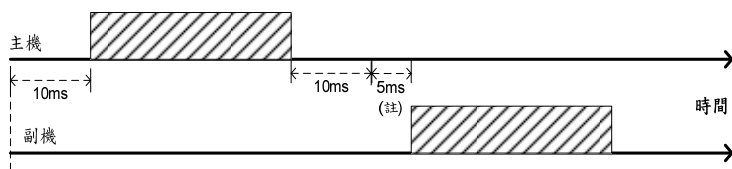

通訊開機或重設

當變頻器開機，或改變相關通訊設定項次後，經過 10ms 主機方可開始通訊傳輸；將命令訊息傳送出去後，副機需 5ms 的處理時間才會把回傳訊息傳送回主機。如果是廣播則不回傳，主機可在 5ms 後再傳送命令訊息。

【註】如果訊息為讀、寫設定項次，則須等 100ms 以上的處理時間才會回傳訊息。

6 通訊說明

6-7 異常通訊處理

1. 當在通訊網路發生錯誤時，變頻器提供了自我檢測功能，辨認發生錯誤的地方。請檢查通訊功能設定，解決通訊錯誤。(請參照 6-2：通訊參數設定)
2. 當主機接收到變頻器回傳的錯誤訊息時，代表命令訊息為不合法的。以下為錯誤訊息的通訊格式

錯誤訊息

通訊位址	功能碼	錯誤碼	CRC 檢查碼	
			LSB	MSB
02H	1xxxxxxxB	xxH	xxH	xxH

其中功能碼是將原本命令訊息的功能碼最高位元(bit7)設為 1，錯誤碼則依不同錯誤給予不同數值；以下為錯誤碼敘述：

錯誤碼	名稱	說明
00	串列通訊格式錯誤	串列通訊同位元錯誤
01		串列通訊資料框錯誤
02		串列通訊位元溢位
03	Modbus 功能碼錯誤	功能碼不在 03H,06H,08H,10H 其中
04	Modbus CRC 錯誤	CRC 檢查碼錯誤
05	Modbus 資料錯誤	1.傳送資料列長度與協定不符 2.寫入暫存器資料超出範圍
06	Modbus 暫存器屬性錯誤	暫存器寫入唯讀暫存器
07	Modbus 暫存器錯誤	處理無定義暫存器

6-8 暫存器和指令說明

●寫入暫存器

暫存器編號	名稱	說明	
AGnnH 【註4】	設定項次	設定、監看變頻器設定項次； G表示群組，nn表示項次 例如：F1.20由A114H表示	
2000H	運轉操作命令 1	b0~b1	00:無作用
			01:停止
			10:啟動
			11:寸動指令
		b2~b3	保留
			b4~b5
		01:正轉指令	
		10:反轉指令	
		11:改變轉向指令	
		b6~b7	00:主加/減速時間
			01:一段加/減速時間
			10:二段加/減速時間
			11:三段加/減速時間
		b8~bA	000:主速度(通訊)
			001:多段速度 1
			010:多段速度 2
			011:多段速度 3
			100:多段速度 4
			101:多段速度 5
			110:多段速度 6
111:多段速度 7			
bB	保留		
bC~bD	00:無作用		
	01:b6~bA有作用【註1】		
	10:多機能功能由通訊控制		
11:前兩者關閉			
	bE~bF	保留	
2001H	頻率命令	主頻率由通訊設定 (單位:0.01Hz)	
2002H	運轉操作命令 2	b0	1:外部異常指令
		b1	1:重置指令
		b2	1:寸動指令
		b3	1:遮斷輸出指令
		b4	1:自由運轉停止指令
		b5	1:副加,減速指令
		b6	1:加/減速禁止指令
		b7	1:選擇類比輸入源
		b8	1:直流制動允許
		b9	1:選擇副頻率
		bA~bF	保留

6 通訊說明

●讀出暫存器

暫存器編號	名稱	說明	
2100H	變頻器異常碼	00H	無異常
		01H	過電流 (OC)
		02H	過電壓 (OE)
		03H	變頻器過熱 (OH)
		04H	變頻器過負載 (OL1)(OL2)
		05H	馬達過負載 (OL)
		06H	外部異常 (EF)
		07H	短路保護 (SC)
		08H	A/D 轉換器故障 (AdEr)
		09H	保留
		0AH	保留
		0BH	保留
		0CH	保留
		0DH	接地漏電保護 (GF)
		0EH	運轉中電源電壓過低 (LE1)
0FH	記憶體故障 (EEr)		
10H	保留		
11H	遮斷保護 (bb)		
12H	系統過負載 (OLO)		
13H	保留		
14H	保留		
15H	自由運轉停止 (Fr)		
2101H	變頻器狀態 1	b0~b7	保留
		b8	1:頻率由通訊設定
		b9	1:頻率由類比控制
		bA	1:運轉指令通訊控制
		bB	1:參數鎖定
		bC	1:運轉中狀態
		bD	1:寸動狀態
		bE	1:正轉指示
bF	1:反轉指示		
2102H	頻率命令	監看變頻器目前的頻率命令 (單位:0.01Hz)	
2103H	輸出頻率	監看變頻器目前的輸出頻率 (單位:0.01Hz)	
2104H	輸出電流	監看變頻器目前的輸出電流 (單位:0.1A)	
2105H	DC bus 電壓	監看變頻器目前的 DC bus 電壓 (單位:0.1V)	
2106H	輸出電壓	監看變頻器目前的交流輸出電壓 (單位:0.1V)	
2107H	頻率指令段速	監看變頻器目前的運轉頻率的段速【註2】	
2108H	保留		
2109H	保留		

暫存器編號	名稱	說明	
210AH	保留		
210BH	保留		
210CH	保留		
210DH	保留		
210EH	保留		
210FH	保留		
2300H	控制端子狀態	b0	保留
		b1	保留
		b2	1:X1 動作
		b3	1:X2 動作
		b4	1:X3 動作
		b5	1:X4 動作
		b6	保留
		b7	保留
		b8	1:Y1(TA/TC)檢出
		b9	保留
		bA	保留
		bB	保留
		bC	1:主速由類比輸入
		bD	1:主速由操作面板設定
		bE	1:主速由 UP/DOWN 設定
bF	1:主速由通訊輸入		
2301H	變頻器狀態 2	b0	保留
		b1	1:等速
		b2	1:零速
		b3	1:頻率偵測
		b4	1:過負載
		b5	1:失速防止
		b6	保留
		b7	1:煞車動作
		b8	保留
		b9	保留
		bA	1:異常信號
bB~bF	保留		
2302H	保留		
2303H	異常履歷 1	第一異常履歷【註 3】	
2304H	異常履歷 2	第二異常履歷【註 3】	
2305H	異常履歷 3	第三異常履歷【註 3】	
2306H	異常履歷 4	第四異常履歷【註 3】	
2307H	異常履歷 5	第四異常履歷【註 3】	

6 通訊說明

註:

1.當有效時，多機能指令—多段指令 1、多段指令 2、多段指令 3，將無動作。

2.頻率命令段速對照表

- 0：類比
- 1：主速度
- 2~16：多段速 2~16
- 17：寸動速度
- 18：UP/DOWN 命令
- 19：程序運轉頻率命令
- 21：通訊

3.異常履歷對照表

異常編號	變頻器顯示值	內容說明
01H	(AdEr)	A/D 轉換器故障
02H	(Fot)	IGBT 模組異常
03H	(EEr1)	變頻器內部記憶體故障
08H	(OC)	變頻器過電流保護
0CH	(OE)	過電壓保護
0DH	(LE1)	運轉中電源電壓過低保護
0EH	(GF)	接地漏電保護
0FH	(OH)	變頻器過熱保護
10H	(OL)	馬達過負載保護
11H	(OL1)	變頻器過負載保護
12H	(OLO)	系統過負載保護
13H	(EF)	外部異常
14H	(PAdF)	遠端操作器於變頻器參數複製中斷線
16H	(ntcF)	溫度感測器異常
17H	(OH2)	馬達過熱
18H	(noFb)	PID 回授信號異常
19H	(OL2)	變頻器電流限制

4. AGnnH—可寫入，可讀出。

2000H~2002H—可寫入，不可讀出。

2100H~210FH—不可寫入，可讀出。

6-9 程式範例-暫存器和指令

6-9-1 存取變頻器設定項次-寫入操作

- a. 設定設定項次 F2.00 (主速度) = 30 Hz
- b. 速度 = 30Hz \rightarrow 30.00Hz(最小單位: 0.01Hz) \rightarrow 30.00 / 0.01 = 3000 (十進制)=0BB8H(十六進制)

主機寫入副機命令訊息(不含 CRC 檢查碼)

通訊位址	功能碼	暫存器位址		暫存器資料	
		高位元	低位元	高位元	低位元
01H	06H	A2H	00H	0BH	B8H

6-9-2 主機控制變頻器-寫入操作

主機利用 Modbus 通訊控制變頻器運轉操作命令 1 功能。藉由以下說明如何做通訊控制：

1. 啟動變頻器：

主機將資料 0002H 寫入變頻器的暫存器 2000H 之中。

- a. 變頻器暫存器寫入運轉操作命令 1 位址：2000H
- b. 暫存器啟動指令的資料：0002H

通訊位址	功能碼	暫存器位址		暫存器資料	
		高位元	低位元	高位元	低位元
01H	06H	20H	00H	00H	02H

2. 正轉指令：

主機將資料 0010H 寫入變頻器的暫存器 2000H 之中。

- a. 變頻器暫存器寫入運轉操作命令 1 位址：2000H
- b. 暫存器正轉指令的資料：0010H

通訊位址	功能碼	暫存器位址		暫存器資料	
		高位元	低位元	高位元	低位元
01H	06H	20H	00H	00H	10H

6 通訊說明

3.速度設定(頻率命令)：

設定速度 30.05Hz (最小單位：0.01Hz)

a. 變頻器寫入速度設定(頻率命令)位址：2001H

b. 轉換 30.05Hz 成十六進制數值：

$30.05 / 0.01$ (最小單位) = 3005 (十進制) = 0BBDH (十六進制)

通訊位址	功能碼	暫存器位址		暫存器資料	
		高位元	低位元	高位元	低位元
01H	06H	20H	01H	0BH	BDH

4.主加速度/主減速度時間設定：

設定主加速/主減速時間=1.5 秒 (最小單位：0.1 秒)

a. 設定 F2.18 (主加速時間)=1.5 秒

轉換 F2.18 成十六進制數值：18 (十進制)=12H (十六進制)

轉換 1.5 秒成十六進制數值：1.5 x 10 (最小單位)=15(十進制)=000FH(十六進制)

b. 設定 F2.19 (主減速時間)=1.5 秒

轉換 F2.19 成十六進制數值：19 (十進制)=13H (十六進制)

c. 選擇主加速/主減速時間命令：暫存器位址：2000H，

暫存器資料= 0000H (b6~b7)

設定加速時間 F2.18=1.5 秒

通訊位址	功能碼	暫存器位址		暫存器資料	
		高位元	低位元	高位元	低位元
01H	06H	A2H	12H	00H	0FH

設定減速時間 F_020=1.5 秒

通訊位址	功能碼	暫存器位址		暫存器資料	
		高位元	低位元	高位元	低位元
01H	06H	A2H	13H	00H	0FH

選擇主加速/主減速時間

通訊位址	功能碼	暫存器位址		暫存器資料	
		高位元	低位元	高位元	低位元
01H	06H	20H	00H	00H	00H

6-9-3 主機控制變頻器-讀出操作

1. 變頻器異常中斷(異常碼)：

範例：變頻器異常中斷，由於“GF”(接地漏電保護)和主機上錯誤訊息顯示。

a. 主機從暫存器 2100H 位址(變頻器異常碼)讀出 1 個變頻器暫存器資料。

-暫存器位址：2100H

-讀出暫存器個數：1 → 0001H

命令訊息 (主機到變頻器)

通訊位址	功能碼	暫存器位址		讀出暫存器個數	
		高位元	低位元	高位元	低位元
01H	03H	21H	00H	00H	01H

- b. 當"GF"發生時, 變頻器回傳異常訊息到主機:
-GF 異常碼: 0EH

回傳訊息 (變頻器到主機)

通訊位址	功能碼	位元資料	2100H(暫存器)資料	
			高位元	低位元
01H	03H	02H	00H	0EH

2. 讀出變頻器輸出頻率：

範例：假如變頻器輸出頻率=40.65Hz，從主機上讀出變頻器輸出資料40.65Hz。

- a. 主機從暫存器 2103H 位址(輸出頻率)讀出 1 個變頻器暫存器資料。
-暫存器位址：2103H
-讀出暫存器個數：1 → 0001H

命令訊息 (主機到變頻器)

通訊位址	功能碼	暫存器位址		讀出暫存器個數	
		高位元	低位元	高位元	低位元
01H	03H	21H	03H	00H	01H

- b. 變頻器回傳輸出頻率到主機
-從變頻器讀出輸出頻率(2103H 暫存器資料)：

回傳訊息 (變頻器到主機)

通訊位址	功能碼	位元資料	2103H(暫存器)資料	
			高位元	低位元
01H	03H	02H	0FH	E1H

- c. 主機轉換暫存器資料：0FE1H (十六進制)=4065 (十進制)
d. 顯示輸出頻率(最小單位=0.01)：4065 x 0.01 = 40.65 (單位：Hz)

7 操作程序與異常保護

7 操作程序與異常保護

7-1 操作程序



危險

1. 變頻器電源指示燈(CRG)未熄滅前，請勿進行拆線工作。



注意

1. 配線完成後應檢查配線是否破損，以免漏電或短路。
2. 端子上之螺絲是否鎖緊。

- A. 確定電源、電壓、馬達、變頻器是否匹配。
- B. 將電源連接到變頻器R/L1, S/L2, T/L3(三相電源)或是R/L1, S/L2(單相電源)端子。
- C. 送電後設定好所需的參數和功能，並且在U/T1, V/T2, W/T3端子量測變頻器的輸出電壓，並確認輸出電壓和需求值，完成後按“”鍵。
- D. 關掉電源並且等到變頻器的電源指示燈熄滅，然後連接變頻器U/T1, V/T2, W/T3 端子到馬達。
- E. 電源開啟後利用變頻器慢速驅動馬達，確認馬達旋轉方向是否正確後，再慢慢增加馬達轉速。
- F. 馬達啟動或停止，必須以變頻器訊號控制代替以電源開關切換的方式，如果以電源開關切換的方式控制馬達，會降低變頻器的壽命。
- G. 變頻器和馬達之間請勿加裝電磁接觸器(MC);若無法避免使用時，電磁接觸器(MC)需比變頻器提早動作(閉合/斷開)。
- H. 當使用單相電源驅動三相系列變頻器(非標準單相電源輸入機種)，先確認馬達的馬力數，然後將馬達額定電流乘以2，得到變頻器額定電流的基準值。對於以單相電源驅動三相系列變頻器，選用的變頻器額定電流規格必須至少等於電流基準值。

公式：馬達額定電流 × 2 = 變頻器額定輸出電流

範例：

a. 變頻器選用：

馬達規格：220Vac, 1HP；額定電流：3.1A

變頻器額定電流基準值 = 3.1 (A) × 2倍 = 6.2 (A)

變頻器規格：220Vac, 1HP變頻器 = 4.2A (額定輸出電流)

2HP變頻器 = 8A (額定輸出電流)

⇒ 選用2HP變頻器與1HP交流馬達配合

⇒

b. 連接單相電源線到R/L1, S/L2端子。

c. 參數設定：

請重新設定以下設定項次。如果沒修改參數設定，馬達和變頻器可能會損壞。

F4.08：馬達額定電流 =3.1A (依照馬達實際額定電流設定)

F4.28：過負載檢出準位=80 (原本出廠值160%應減半)

F3.04：等速中失速防止=80 (原本出廠值160%應減半)

7 操作程序與異常保護

7-2 異常保護顯示與處理對策

a 說明：

變頻器有完善的保護功能，在異常發生時保護變頻器和馬達；當異常發生時，變頻器會跳脫保護並在操作器上顯示異常訊息。異常排除後，可按壓操作器上

“STOP/RESET”鍵，或是透過多機能輸入端子從外部下達重置命令。

b 保護內容及處理對策一覽表：

變頻器異常跳脫訊息

顯示	說明	原因	處理對策
<p>Fot</p> 	<p>IGBT模組異常</p>	<ul style="list-style-type: none"> ●變頻器驅動電源系統異常。 ●變頻器輸出異常過電流。 ●IGBT模組溫度過高。 	<p>當多機能輸入端子重置指令或按“STOP/RESET”都無效時，請送廠維修。</p>
<p>GF</p> 	<p>接地漏電保護</p> <ul style="list-style-type: none"> ●變頻器輸出端接地且接地電流超過接地漏電檢知準位以上。 ●接地漏電檢知準位：F4.01 	<p>變頻器輸出端短路或接地。</p>	<ul style="list-style-type: none"> ●檢查馬達是否有絕緣劣化。 ●檢查馬達線是否有破損。
<p>OC</p> 	<p>變頻器過電流保護</p> <ul style="list-style-type: none"> ●運轉電流超過變頻器額定電流之220%以上。 	<ul style="list-style-type: none"> ●變頻器輸出端短路。 ●負載過重。 ●加速時間太短。 ●自然停止時再啟動。 ●使用特殊馬達。 	<ul style="list-style-type: none"> ●檢查U/T1,V/T2,W/T3間是否有短路。 ●檢查馬達與變頻器是否匹配。 ●檢查馬達是否有超額運轉。
<p>OL</p> 	<p>馬達過負載保護</p> <ul style="list-style-type: none"> ●運轉電流達馬達額定電流150%動作時間。 ●動作時間：F4.10 	<ul style="list-style-type: none"> ●馬達負載過大。 ●V/F曲線設定的電壓過高或過低。 ●馬達額定電流設定不適當。 	<ul style="list-style-type: none"> ●檢查馬達負載是否過大。 ●檢查加/減速時間是否過短。 ●檢查V/F設定是否適當。 ●檢查馬達額定電流設定是否適當。

變頻器異常跳脫訊息

顯示	說明	原因	處理對策
OL1 	變頻器過負載保護 ●運轉電流達變頻器額定電流 150% 1 分鐘。	●馬達負載過大。 ●V/F 曲線設定的電壓過高或過低。 ●變頻器容量太小。	●檢查馬達負載是否過大。 ●檢查加/減速時間是否過短。 ●檢查V/F設定是否適當。 ●加大變頻器容量。
OL2 	變頻器電流限制 運轉電流超過變頻器額定電流 200%跳脫條件。	●負載過重。 ●加速時間太短。 ●自然停止時再啟動。	●檢查馬達與變頻器是否匹配。 ●檢查馬達是否有超額運轉。
OL3 	煞車晶體過載	煞車動作頻率過高，造成煞車晶體溫度太高。	增加“減速時間”設定。
OLO 	系統過負載保護 ●馬達負載系統過大，運轉電流達動作條件。 ●動作準位：F4.28 ●動作時間：F4.29	---	確認機械設備的使用。
OE 	過電壓保護 ●變頻器內部 DC bus 電壓超過保護準位。 ●100V/200V系列：約DC410V ●400V系列：約 DC820V	慣性負載，因馬達減速時間過短，造成回升電壓太高。 電源電壓過高。	●增加“減速時間”設定。 ●使用高轉矩制動方式。 ●加裝動態煞車器，降低輸入電壓。 檢查輸入電源，是否在變頻器額定輸入範圍內。
LE1 	運轉中電源電壓過低保護 變頻器內部 DC bus 電壓低於 70%以下 (200V、400V 系列)及 50%以下(100V 系列)。	●輸入電源欠相。 ●瞬間停電。 ●輸入電源電壓變動過大。 ●設備重載，造成電源壓降過高。	提高電源容量，避免電源壓降過高。
ntcF 	溫度感測器異常	變頻器內 NTC 溫度感測器異常。	請送廠維修。

7 操作程序與異常保護

變頻器異常跳脫訊息

顯示	說明	原因	處理對策
OH 	變頻器過熱保護 ●變頻器的散熱片溫度達跳脫準位。 ●跳脫準位：F4.12	●環境溫度過高。 ●散熱片有異物。 ●變頻器的冷卻風扇異常。	●改善通風系統。 ●清除散熱片積塵。 ●更換冷卻風扇。
OH2 	馬達過熱 ●馬達內部溫度過高，超過跳脫準位 ●跳脫準位：F4.23	馬達過熱。	●檢查馬達負載是否過大。 ●檢查加/減速時間是否過短。 ●檢查 V/F 設定是否適當。
noFb 	PID 回授信號異常	回授斷線。	檢查回授信號線路是否正常。
AdEr 	A/D 轉換器故障	---	請送廠維修。
EF 	外部異常	多機能輸入端子接收外部異常信號。	清除外部異常來源後按 RESET。
EEr 	EEPROM 異常	●EEPROM 資料寫入不良。 ●EEPROM 元件故障。	●請將參數出廠化後並重新開機。 ●無法排除異常，請送廠維修。
EEr1 	變頻器內部記憶體故障	CPU RAM 無法正常工作。	請送廠維修。
EEr2 	變頻器內部記憶體故障	CPU 軟體檢查碼錯誤。	請送廠維修。

變頻器警告訊息



*當變頻器顯示以下訊息，變頻器會停止輸出；異常狀態移除後，變頻器會自動恢復到正常狀態。

顯示	說明	原因	處理對策
<p>OLO</p> 	<p>系統過負載保護</p> <ul style="list-style-type: none"> ●馬達負載系統過大，運轉電流達動作條件。 ●動作準位：F4.28 ●動作時間：F4.29 	---	確認機械設備的使用。
<p>Hv</p> 	<p>電源電壓過高</p> <ul style="list-style-type: none"> ●停止中變頻器內部 DC bus 電壓超過保護準位。 	電源電壓過高。	檢查輸入電源，是否在變頻器額定輸入範圍內。
<p>db</p> 	<p>煞車晶體動作</p> <ul style="list-style-type: none"> ●變頻器內部 DC bus 電壓超過設定準位。 ●設定準位：F3.27 	馬達減速時間過短，造成回升電壓太高。	<ul style="list-style-type: none"> ●增加“減速時間”設定。 ●使用高轉矩制動方式。 ●加裝動態煞車器，降低輸入電壓。
<p>LE</p> 	<p>電源電壓過低保護</p>	電源電壓過低。	檢查電源電壓是否正常。
<p>OHt</p> 	<p>變頻器過熱保護</p> <ul style="list-style-type: none"> ●變頻器的散熱片溫度達過熱警示準位。 ●警示準位：F4.14 	<ul style="list-style-type: none"> ●環境溫度過高。 ●散熱片有異物。 ●變頻器的冷卻風扇異常。 	<ul style="list-style-type: none"> ●改善通風系統。 ●清除散熱片積塵。 ●更換冷卻風扇。
<p>OH1</p> 	<p>馬達過熱</p> <ul style="list-style-type: none"> ●馬達內部溫度過高，超過警示準位 ●警示準位：F4.21 	馬達過熱。	<ul style="list-style-type: none"> ●檢查馬達負載是否過大。 ●檢查加/減速時間是否過短。 ●檢查 V/F 曲線設定是否適當。
<p>bb</p> 	<p>遮斷輸出</p>	遮斷輸出指令動作，變頻器停止輸出。	清除遮斷輸出指令。
<p>Fr</p> 	<p>自由運轉停止</p>	自由運轉停止指令動作，變頻器停止輸出。	清除自由運轉停止指令。

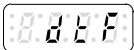
7 操作程序與異常保護

dIF 	正/反轉運轉指令同時動作	多機能輸入端子操作不當。	檢查正反轉控制端子接線。
---	---------------------	--------------	--------------

變頻器警告訊息

顯示	說明	原因	處理對策
 與頻率命令 交替顯示	無正/反轉運轉指令	---	檢查正/反轉控制端子接線。
WvF 	不同程式版本的變頻器執行交互做複製	變頻器版本不同。	檢查變頻器軟體版本是否相同。
Cot 	Modbus 通訊逾時	<ul style="list-style-type: none"> ●通訊線鬆脫或接線錯誤。 ●主/副機通訊設定不同。 	<ul style="list-style-type: none"> ●檢查通訊線接線是否正確。 ●檢查通訊設定是否適當。

附錄 A 外型尺寸圖

(1) 變頻器尺寸圖

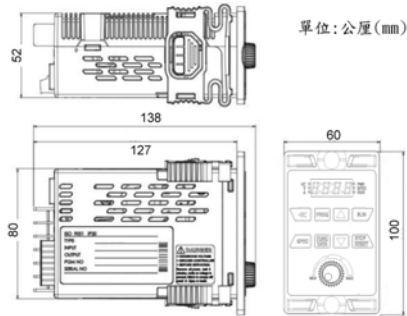

(2) 安裝尺寸開孔圖:

固定方式 1:免螺絲固定器(標準固定)

2:螺絲固定(振動環境使用)

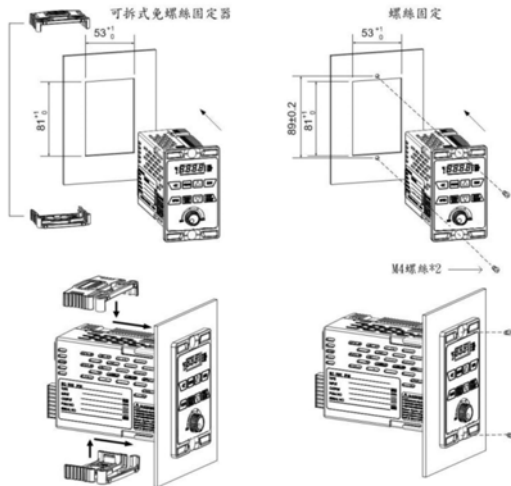

※外型尺寸若有變更，依實物為準。

